



PULEGGE TRAPEZOIDALI PER BUSSOLA CONICA

V-Belt pulleys for taper bushes
Keilriemenscheiben für Spannbuchsen
Poulies trapézoïdales à moyeu amovible
Poleas trapezoidales para casquillos conicos

Pulegge trapezoidali per bussola conica / V-Belt pulleys for taper bushes Keilriemenscheiben für Spannbuchsen / Poulies trapézoïdales à moyeu amovible Poleas trapezoidales para casquillos conicos

Le pulegge per cinghie trapezoidali presentate dalla SATI nel presente catalogo sono tutte costruite secondo le tabelle ISO 4183 e DIN 2211-3.

Il materiale impiegato nella costruzione delle medesime è in ghisa EN-GJL-200 UNI EN 1561 e, successivamente alle lavorazioni meccaniche, subiscono un trattamento superficiale di FOSFATAZIONE.

Tutte le pulegge sono equilibrate STATICAMENTE ed idonee ad un funzionamento fino alla velocità periferica di 35 m/s.

La gamma proposta nel seguente catalogo, comprende: PULEGGE TRAPEZOIDALI, per bussola conica, serie ZT..... AT..... BT..... CT..... PULEGGE TRAPEZOIDALI monoblocco (con mozzo pieno) serie ZM..... AM..... BM..... CM..... PULEGGE TRAPEZOIDALI per calettatore.

V-belt pulleys proposed by SATI in this catalogue are all manufactured according to ISO 4183 and DIN 2211-3 norms.

The material used for the construction of these pulleys is cast iron EN-GJL-200 UNI EN 1561 and after the machining all pulleys are being PHOSPHATED.

All pulleys are STATICALLY balanced and suitable for peripheral speed up to 35 m/s.

The range proposed in this catalogue is the following:

V-BELT PULLEYS for taper bush, series ZT..... AT..... BT..... CT..... V-BELT PULLEYS with solid hub, series ZM..... AM..... BM..... CM..... V-BELT PULLEYS for locking devices.

Die Keilriemenscheiben, die von SATI in diesem Katalog dargestellt sind, sind alle nach ISO 4183 und DIN 2211-3 hergestellt worden.

Das fuer die Produktion verwendete Material ist Grauguss EN-GJL-200 UNI EN 1561 und nach der Bearbeitung werden alle Keilriemenscheiben PHOSPHATIERT.

Alle Keilriemenscheiben sind STATISCH ausgewuchtet und fuer eine peripherische Betriebsgeschwindigkeit bis 35 m/s.

Die in diesem Katalog angegebene Palette ist die folgende: KEILRIEMENSCHLEIBEN fuer Spannbuchse, Serie ZT..... AT..... BT..... CT..... KEILRIEMENSCHLEIBEN ungebohrt, Serie ZM..... AM..... BM..... CM..... KEILRIEMENSCHLEIBEN fuer Spannsätze.

Les poulies trapézoïdales presentées par la SATI sur ce catalogue sont toutes fabriquées suivant les normes ISO 4183 et DIN 2211-3.

Le materiel utilisé pour la fabrication des poulies est la fonte EN-GJL-200 UNI EN 1561 et après l'usinage elles sont toutes exposées à un traitement de PHOSPHATATION.

Toutes les poulies sont équilibrées STATIQUEMENT et propres à tourner à une vitesse périphérique jusqu'à 35 m/s.

La gamme proposée dans ce catalogue est la suivante: POULIES TRAPEZOÏDALES pour moyeu amovible, série ZT..... AT..... BT..... CT..... POULIES TRAPEZOÏDALES à moyeu plein, série ZM..... AM..... BM..... CM..... POULIES TRAPEZOÏDALES pour à moyeu de serrage.

Las poleas para correas trapezoidales presentadas por la SATI en el presente catálogo están todas construidas según las tablas ISO 4183 y DIN 2211-3.

El material empleado en la construcción de las mismas es el hierro fundido EN-GJL-200 UNI EN 1561 y después de las elaboraciones mecánicas están sometidas a un tratamiento superficial de FOSFATACIÓN.

Todas las poleas están equilibradas ESTÁTICAMENTE y son adecuadas para un funcionamiento de una velocidad de hasta 35 m/s.

La gama propuesta en el siguiente catálogo comprende: POLEAS TRAPEZOIDALES para casquillos cónicos, serie ZT..... AT..... BT..... CT..... POLEAS TRAPEZOIDALES con cubo pleno, serie ZM..... AM..... BM..... CM..... POLEAS TRAPEZOIDALES para casquillos de fijación.

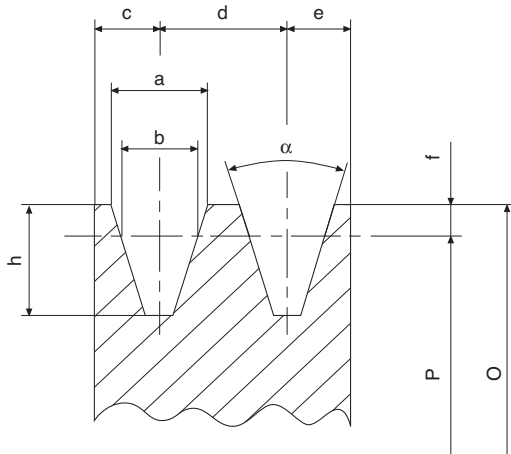

Calcolo della velocità periferica Vp in m/s
Calculation of peripheral speed Vp in m/s
Berechnung der Umfangsgeschwindigkeit Vp in m/s
Calcul de la vitesse périphérique Vp m/s
Cálculo de la velocidad periférica Vp en m/s

$$V_p = \frac{p \cdot P \cdot \text{rpm}}{60 \cdot 1000} @ \frac{P \cdot \text{rpm}}{19100} \quad V_p \leq 35 \text{ m/s}$$

P = Diametro primitivo in mm
Pitch diameter in mm
Teildurchmesser in mm
Diamètre primitif en mm
Diámetro primitivo en mm

rpm = Giri al minuto
Revolutions per minute
Umdrehungen pro Minute
Tours par minute
Revoluciones por minuto

Dimensioni puleggia / Pulley dimintions / Keilriemenscheibenabmessungen / Dimensions poulie / Dimensiones polea

| | a | b | c | d | e | f | h | 34° | 38° |
|-----|------|------|------|------|------|-----|------|---------|---------|
| SPZ | 9,7 | 8,5 | 8,0 | 12,0 | 8,0 | 2,0 | 11,0 | P ≤ 80 | P > 80 |
| SPA | 12,7 | 11,0 | 10,0 | 15,0 | 10,0 | 2,8 | 13,8 | P ≤ 118 | P > 118 |
| SPB | 16,3 | 14,0 | 12,5 | 19,0 | 12,5 | 3,5 | 17,5 | P ≤ 190 | P > 190 |
| SPC | 22,0 | 19,0 | 17,0 | 25,5 | 17,0 | 4,8 | 23,8 | P ≤ 315 | P > 315 |

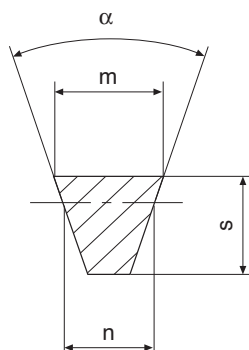

Dimensioni cinghia / Belt dimintions / Riemenabmessungen / Dimensions courroie / Dimensiones correa

| | m | s | n |
|-----|------|----|------|
| SPZ | 9,7 | 8 | 8,5 |
| SPA | 12,7 | 10 | 11,0 |
| SPB | 16,3 | 13 | 14,0 |
| SPC | 22,0 | 18 | 19,0 |

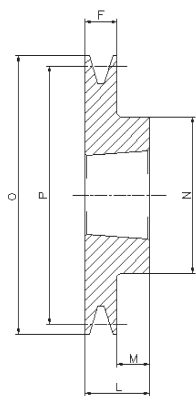

1

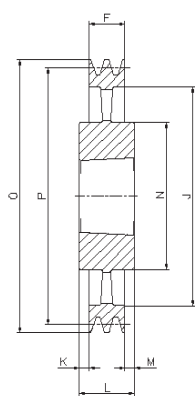

4

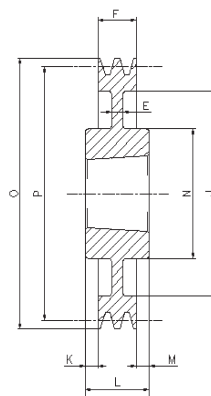

7

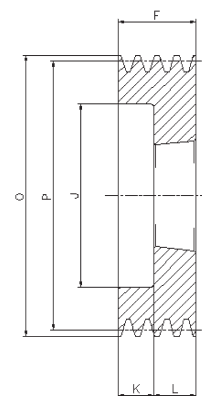

9

SPZ/1

| Cod. interno Internal code Intern Code Code interne Código interno | Tipo Type Typ Type Tipo | Gole Grooves Rillen Gorges Canales | P | O | Forma Form Forme Forme Forma | Bussola Bush Buchse Moyeu Casquillo | Ø MAX | E | F | J | K | L | M | N |
|--|-------------------------------------|--|-----|-----|--|---|----------|----|----|-----|------|----|------|-----|
| ZT00501 | SPZ 50-01 | 1 | 50 | 54 | 9 | 1008 | 25 | - | 37 | 26 | 12,0 | 25 | - | - |
| ZT00561 | SPZ 56-01 | 1 | 56 | 60 | 9 | 1008 | 25 | - | 37 | 32 | 12,0 | 25 | - | - |
| ZT00601 | SPZ 60-01 | 1 | 60 | 64 | 1 | 1008 | 25 | - | 22 | - | - | 22 | - | - |
| ZT00631 | SPZ 63-01 | 1 | 63 | 67 | 1 | 1108 | 28 | - | 16 | - | - | 22 | 6,0 | 56 |
| ZT00671 | SPZ 67-01 | 1 | 67 | 71 | 1 | 1108 | 28 | - | 16 | - | - | 22 | 6,0 | 60 |
| ZT00711 | SPZ 71-01 | 1 | 71 | 75 | 1 | 1108 | 28 | - | 16 | - | - | 22 | 6,0 | 60 |
| ZT00751 | SPZ 75-01 | 1 | 75 | 79 | 1 | 1108 | 28 | - | 16 | - | - | 22 | 6,0 | 60 |
| ZT00801 | SPZ 80-01 | 1 | 80 | 84 | 1 | 1210 | 32 | - | 16 | - | - | 25 | 9,0 | 75 |
| ZT00851 | SPZ 85-01 | 1 | 85 | 89 | 1 | 1210 | 32 | - | 16 | - | - | 25 | 9,0 | 80 |
| ZT00901 | SPZ 90-01 | 1 | 90 | 94 | 1 | 1210 | 32 | - | 16 | - | - | 25 | 9,0 | 80 |
| ZT00951 | SPZ 95-01 | 1 | 95 | 99 | 1 | 1210 | 32 | - | 16 | - | - | 25 | 9,0 | 85 |
| ZT01001 | SPZ100-01 | 1 | 100 | 104 | 1 | 1210 | 32 | - | 16 | - | - | 25 | 9,0 | 85 |
| ZT01061 | SPZ106-01 | 1 | 106 | 110 | 1 | 1610 | 42 | - | 16 | - | - | 25 | 9,0 | 92 |
| ZT01121 | SPZ112-01 | 1 | 112 | 116 | 1 | 1610 | 42 | - | 16 | - | - | 25 | 9,0 | 92 |
| ZT01181 | SPZ118-01 | 1 | 118 | 122 | 1 | 1610 | 42 | - | 16 | - | - | 25 | 9,0 | 92 |
| ZT01251 | SPZ125-01 | 1 | 125 | 129 | 1 | 1610 | 42 | - | 16 | - | - | 25 | 9,0 | 92 |
| ZT01321 | SPZ132-01 | 1 | 132 | 136 | 1 | 1610 | 42 | - | 16 | - | - | 25 | 9,0 | 92 |
| ZT01401 | SPZ140-01 | 1 | 140 | 144 | 1 | 1610 | 42 | - | 16 | - | - | 25 | 9,0 | 92 |
| ZT01501 | SPZ150-01 | 1 | 150 | 154 | 1 | 1610 | 42 | - | 16 | - | - | 25 | 9,0 | 92 |
| ZT01601 | SPZ160-01 | 1 | 160 | 164 | 1 | 1610 | 42 | - | 16 | - | - | 25 | 9,0 | 92 |
| ZT01701 | SPZ170-01 | 1 | 170 | 174 | 1 | 1610 | 42 | - | 16 | - | - | 25 | 9,0 | 92 |
| ZT01801 | SPZ180-01 | 1 | 180 | 184 | 7 | 1610 | 42 | 6 | 16 | 152 | - | 25 | 9,0 | 92 |
| ZT01901 | SPZ190-01 | 1 | 190 | 194 | 7 | 1610 | 42 | 12 | 16 | 162 | - | 25 | 9,0 | 92 |
| ZT02001 | SPZ200-01 | 1 | 200 | 204 | 7 | 2012 | 50 | 10 | 16 | 171 | - | 32 | 16,0 | 112 |
| ZT02241 | SPZ224-01 | 1 | 224 | 228 | 7 | 2012 | 50 | 15 | 16 | 195 | - | 32 | 16,0 | 112 |
| ZT02501 | SPZ250-01 | 1 | 250 | 254 | 4 | 2012 | 50 | - | 16 | 221 | 8,0 | 32 | 8,0 | 112 |
| ZT02801 | SPZ280-01 | 1 | 280 | 284 | 4 | 2012 | 50 | - | 16 | 251 | 8,0 | 32 | 8,0 | 112 |
| ZT03151 | SPZ315-01 | 1 | 315 | 319 | 4 | 2012 | 50 | - | 16 | 286 | 8,0 | 32 | 8,0 | 112 |
| ZT03551 | SPZ355-01 | 1 | 355 | 359 | 4 | 2012 | 50 | - | 16 | 326 | 8,0 | 32 | 8,0 | 112 |
| ZT04001 | SPZ400-01 | 1 | 400 | 404 | 4 | 2012 | 50 | - | 16 | 371 | 8,0 | 32 | 8,0 | 112 |
| ZT04501 | SPZ450-01 | 1 | 450 | 454 | 4 | 2517 | 60 | - | 16 | 421 | 14,5 | 45 | 14,5 | 124 |

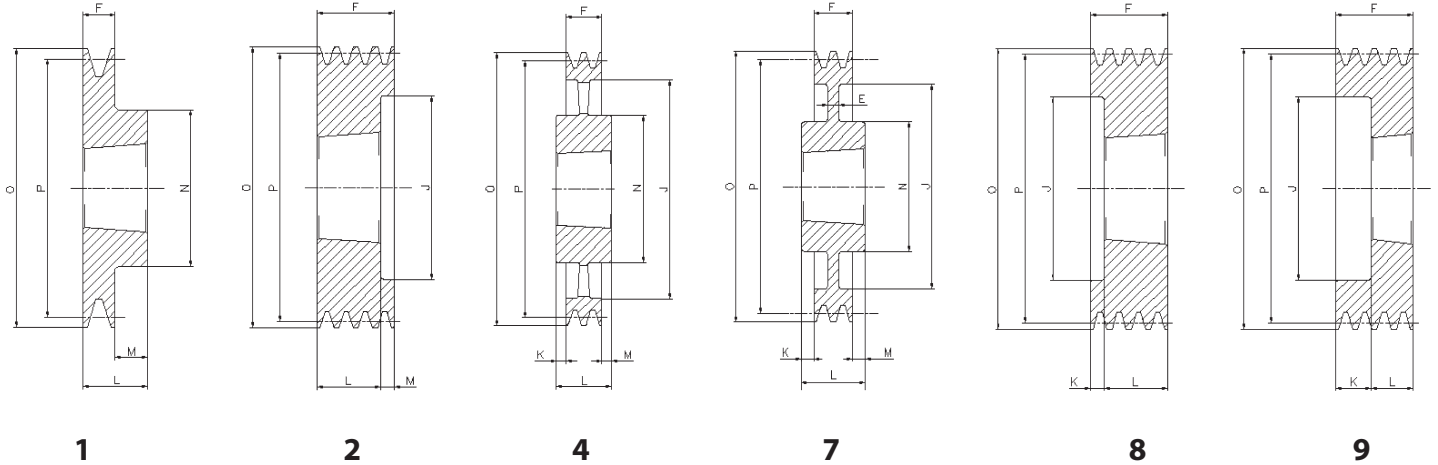

SPZ/2

| Cod. interno Internal code Intern Code Code interne Código interno | Tipo Type Typ Type Tipo | Gole Grooves Rillen Gorges Canales | P | O | Forma Form Forme Forme Forma | Bussola Bush Buchse Moyeu Casquillo | Ø MAX | E | F | J | K | L | M | N |
|--|-------------------------------------|--|------------|-----|--|---|----------|----|----|-----|------|----|-----|-----|
| ZT00502 | SPZ 50-02 | 2 | 50 | 54 | 9 | 1008 | 25 | - | 50 | 26 | 25,0 | 25 | - | - |
| ZT00562 | SPZ 56-02 | 2 | 56 | 60 | 9 | 1008 | 25 | - | 49 | 32 | 27,0 | 22 | - | - |
| ZT00602 | SPZ 60-02 | 2 | 60 | 64 | 9 | 1108 | 28 | - | 49 | 36 | 27,0 | 22 | - | - |
| ZT00632 | SPZ 63-02 | 2 | 63 | 67 | 8 | 1108 | 28 | - | 28 | 40 | 6,0 | 22 | - | - |
| ZT00672 | SPZ 67-02 | 2 | 67 | 71 | 8 | 1108 | 28 | - | 28 | 42 | 6,0 | 22 | - | - |
| ZT00712 | SPZ 71-02 | 2 | 71 | 75 | 8 | 1108 | 28 | - | 28 | 42 | 6,0 | 22 | - | - |
| ZT00752 | SPZ 75-02 | 2 | 75 | 79 | 8 | 1210 | 32 | - | 28 | 51 | 3,0 | 25 | - | - |
| ZT00802 | SPZ 80-02 | 2 | 80 | 84 | 8 | 1210 | 32 | - | 28 | 51 | 3,0 | 25 | - | - |
| ZT00852 | SPZ 85-02 | 2 | 85 | 89 | 8 | 1610 | 42 | - | 28 | 60 | 3,0 | 25 | - | - |
| ZT00902 | SPZ 90-02 | 2 | 90 | 94 | 8 | 1610 | 42 | - | 28 | 61 | 3,0 | 25 | - | - |
| ZT00952 | SPZ 95-02 | 2 | 95 | 99 | 8 | 1610 | 42 | - | 28 | 66 | 3,0 | 25 | - | - |
| ZT01002 | SPZ100-02 | 2 | 100 | 104 | 8 | 1610 | 42 | - | 28 | 71 | 3,0 | 25 | - | - |
| ZT01062 | SPZ106-02 | 2 | 106 | 110 | 8 | 1610 | 42 | - | 28 | 76 | 3,0 | 25 | - | - |
| ZT01122 | SPZ112-02 | 2 | 112 | 116 | 8 | 1610 | 42 | - | 28 | 83 | 3,0 | 25 | - | - |
| ZT01182 | SPZ118-02 | 2 | 118 | 122 | 8 | 1610 | 42 | - | 28 | 90 | 3,0 | 25 | - | - |
| ZT01252 | SPZ125-02 | 2 | 125 | 129 | 8 | 1610 | 42 | - | 28 | 96 | 3,0 | 25 | - | - |
| ZT01322 | SPZ132-02 | 2 | 132 | 136 | 8 | 1610 | 42 | - | 28 | 103 | 3,0 | 25 | - | - |
| ZT01402 | SPZ140-02 | 2 | 140 | 144 | 8 | 1610 | 42 | - | 28 | 111 | 3,0 | 25 | - | - |
| ZT01502 | SPZ150-02 | 2 | 150 | 154 | 1 | 2012 | 50 | - | 28 | - | - | 32 | 4,0 | 112 |
| ZT01602 | SPZ160-02 | 2 | 160 | 164 | 1 | 2012 | 50 | - | 28 | - | - | 32 | 4,0 | 112 |
| ZT01702 | SPZ170-02 | 2 | 170 | 174 | 1 | 2012 | 50 | - | 28 | - | - | 32 | 4,0 | 112 |
| ZT01802 | SPZ180-02 | 2 | 180 | 184 | 7 | 2012 | 50 | 6 | 28 | 152 | - | 32 | 4,0 | 112 |
| ZT01902 | SPZ190-02 | 2 | 190 | 194 | 7 | 2012 | 50 | 12 | 28 | 162 | - | 32 | 4,0 | 112 |
| ZT02002 | SPZ200-02 | 2 | 200 | 204 | 7 | 2012 | 50 | 6 | 28 | 171 | - | 32 | 4,0 | 112 |
| ZT02242 | SPZ224-02 | 2 | 224 | 228 | 4 | 2012 | 50 | 15 | 28 | 195 | - | 32 | 4,0 | 112 |
| ZT02502 | SPZ250-02 | 2 | 250 | 254 | 4 | 2012 | 50 | - | 28 | 221 | 2,0 | 32 | 2,0 | 112 |
| ZT02802 | SPZ280-02 | 2 | 280 | 284 | 4 | 2012 | 50 | - | 28 | 251 | 2,0 | 32 | 2,0 | 112 |
| ZT03152 | SPZ315-02 | 2 | 315 | 319 | 4 | 2012 | 50 | - | 28 | 286 | 2,0 | 32 | 2,0 | 112 |
| ZT03552 | SPZ355-02 | 2 | 355 | 359 | 4 | 2012 | 50 | - | 28 | 326 | 2,0 | 32 | 2,0 | 112 |
| ZT04002 | SPZ400-02 | 2 | 400 | 404 | 4 | 2517 | 60 | - | 28 | 371 | 8,5 | 45 | 8,5 | 124 |
| ZT04502 | SPZ450-02 | 2 | 450 | 454 | 4 | 2517 | 60 | - | 28 | 421 | 8,5 | 45 | 8,5 | 124 |

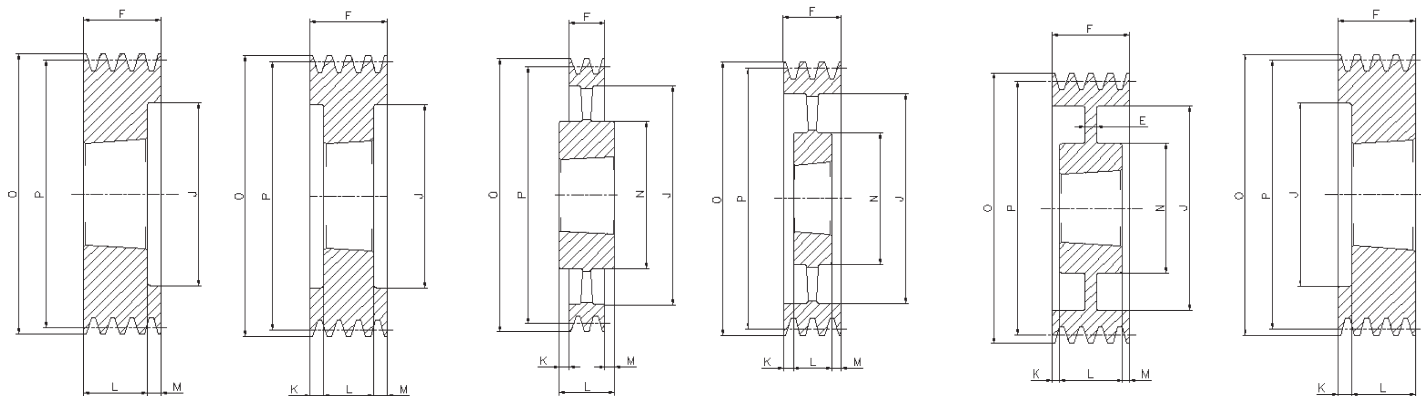

2

3

4

5

6

8

SPZ/3

| Cod. interno Internal code Intern Code Code interne Código interno | Tipo Type Typ Type Tipo | Gole Grooves Rillen Gorges Canales | P | O | Forma Form Forme Forme Forma | Bussola Bush Buchse Moyeu Casquillo | Ø MAX | E | F | J | K | L | M | N |
|--|-------------------------------------|--|-----|-----|--|---|----------|----|----|-----|------|----|-----|-----|
| ZT00633 | SPZ63-03 | 3 | 63 | 67 | 8 | 1108 | 28 | - | 40 | 40 | - | 22 | - | - |
| ZT00673 | SPZ67-03 | 3 | 67 | 71 | 8 | 1108 | 28 | - | 40 | 42 | 18,0 | 22 | - | - |
| ZT00713 | SPZ71-03 | 3 | 71 | 75 | 8 | 1108 | 28 | - | 40 | 42 | 18,0 | 22 | - | - |
| ZT00753 | SPZ75-03 | 3 | 75 | 79 | 8 | 1210 | 32 | - | 40 | 51 | 15,0 | 25 | - | - |
| ZT00803 | SPZ80-03 | 3 | 80 | 84 | 8 | 1210 | 32 | - | 40 | 51 | 15,0 | 25 | - | - |
| ZT00853 | SPZ85-03 | 3 | 85 | 89 | 8 | 1610 | 42 | - | 40 | 60 | 15,0 | 25 | - | - |
| ZT00903 | SPZ90-03 | 3 | 90 | 94 | 8 | 1610 | 42 | - | 40 | 61 | 15,0 | 25 | - | - |
| ZT00953 | SPZ95-03 | 3 | 95 | 99 | 8 | 1610 | 42 | - | 40 | 66 | 15,0 | 25 | - | - |
| ZT01003 | SPZ100-03 | 3 | 100 | 104 | 8 | 1610 | 42 | - | 40 | 71 | 15,0 | 25 | - | - |
| ZT01063 | SPZ106-03 | 3 | 106 | 110 | 8 | 1610 | 42 | - | 40 | 76 | 15,0 | 25 | - | - |
| ZT01123 | SPZ112-03 | 3 | 112 | 116 | 8 | 2012 | 50 | - | 40 | 83 | 8,0 | 32 | - | - |
| ZT01183 | SPZ118-03 | 3 | 118 | 122 | 8 | 2012 | 50 | - | 40 | 90 | 8,0 | 32 | - | - |
| ZT01253 | SPZ125-03 | 3 | 125 | 129 | 2 | 2012 | 50 | - | 40 | 96 | - | 32 | 8,0 | - |
| ZT01323 | SPZ132-03 | 3 | 132 | 136 | 2 | 2012 | 50 | - | 40 | 103 | - | 32 | 8,0 | - |
| ZT01403 | SPZ140-03 | 3 | 140 | 144 | 2 | 2012 | 50 | - | 40 | 111 | - | 32 | 8,0 | - |
| ZT01503 | SPZ150-03 | 3 | 150 | 154 | 2 | 2012 | 50 | - | 40 | 121 | - | 32 | 8,0 | - |
| ZT01603 | SPZ160-03 | 3 | 160 | 164 | 2 | 2012 | 50 | - | 40 | 131 | - | 32 | 8,0 | - |
| ZT01703 | SPZ170-03 | 3 | 170 | 174 | 3 | 2012 | 50 | - | 40 | 141 | 4,0 | 32 | 4,0 | - |
| ZT01803 | SPZ180-03 | 3 | 180 | 184 | 6 | 2012 | 50 | 7 | 40 | 151 | - | 32 | 8,0 | 106 |
| ZT01903 | SPZ190-03 | 3 | 190 | 194 | 6 | 2012 | 50 | 10 | 40 | 161 | 4,0 | 32 | 4,0 | 112 |
| ZT02003 | SPZ200-03 | 3 | 200 | 204 | 6 | 2012 | 50 | 10 | 40 | 171 | 4,0 | 32 | 4,0 | 112 |
| ZT02243 | SPZ224-03 | 3 | 224 | 228 | 6 | 2012 | 50 | 12 | 40 | 195 | 4,0 | 32 | 4,0 | 112 |
| ZT02503 | SPZ250-03 | 3 | 250 | 254 | 5 | 2012 | 50 | - | 40 | 221 | 4,0 | 32 | 4,0 | 112 |
| ZT02803 | SPZ280-03 | 3 | 280 | 284 | 4 | 2517 | 60 | - | 40 | 251 | 2,5 | 45 | 2,5 | 124 |
| ZT03153 | SPZ315-03 | 3 | 315 | 319 | 4 | 2517 | 60 | - | 40 | 286 | 2,5 | 45 | 2,5 | 124 |
| ZT03553 | SPZ355-03 | 3 | 355 | 359 | 4 | 2517 | 60 | - | 40 | 326 | 2,5 | 45 | 2,5 | 124 |
| ZT04003 | SPZ400-03 | 3 | 400 | 404 | 4 | 2517 | 60 | - | 40 | 371 | 2,5 | 45 | 2,5 | 124 |
| ZT04503 | SPZ450-03 | 3 | 450 | 454 | 4 | 2517 | 60 | - | 40 | 421 | 2,5 | 45 | 2,5 | 124 |
| ZT05003 | SPZ500-03 | 3 | 500 | 504 | 4 | 2517 | 60 | - | 40 | 471 | 2,5 | 45 | 2,5 | 124 |
| ZT06303 | SPZ630-03 | 3 | 630 | 634 | 4 | 3020 | 75 | - | 40 | 601 | 5,5 | 51 | 5,5 | 150 |
| ZT08003 | SPZ800-03 | 3 | 800 | 804 | 4 | 3020 | 75 | - | 40 | 771 | 5,5 | 51 | 5,5 | 146 |

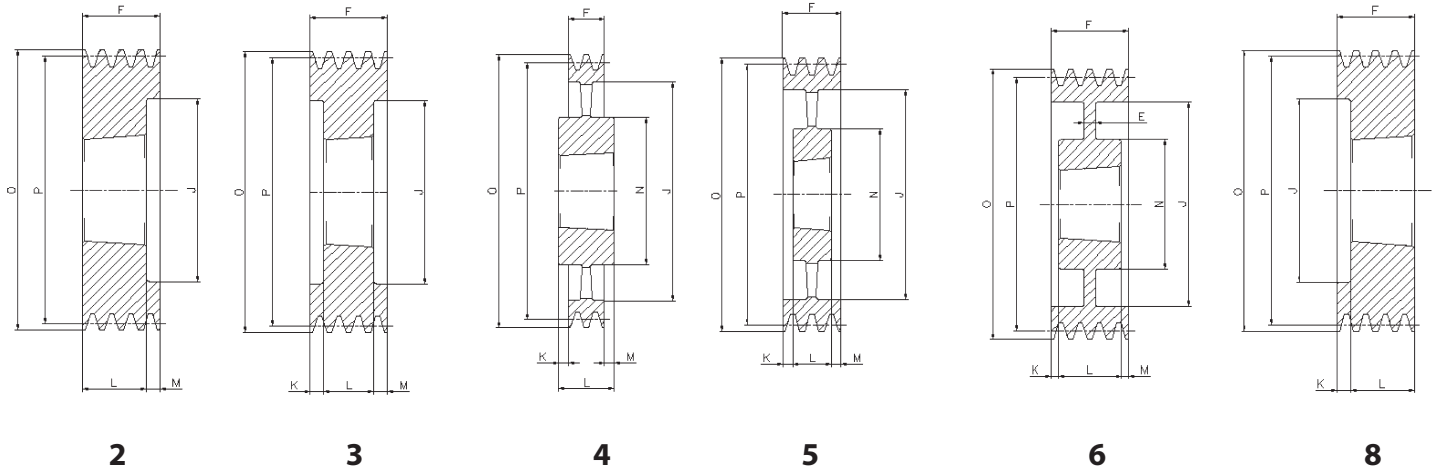

SPZ/4

| Cod. interno Internal code Intern code Code interne Código interno | Tipo Type Typ Type Tipo | Gole Grooves Rillen Gorges Canales | P | O | Forma Form Forme Forme Forma | Bussola Buchse Moyeu Casquillo | ∅ MAX | E | F | J | K | L | M | N |
|--|-------------------------------------|--|------------|-----|--|---|----------|----|----|-----|------|----|------|-----|
| ZT00804 | SPZ 80-04 | 4 | 80 | 84 | 8 | 1210 | 32 | - | 52 | 51 | 27,0 | 25 | - | - |
| ZT00854 | SPZ 85-04 | 4 | 85 | 89 | 8 | 1610 | 42 | - | 52 | 60 | 27,0 | 25 | - | - |
| ZT00904 | SPZ 90-04 | 4 | 90 | 94 | 8 | 1610 | 42 | - | 52 | 61 | 27,0 | 25 | - | - |
| ZT00954 | SPZ 95-04 | 4 | 95 | 99 | 8 | 1610 | 42 | - | 52 | 66 | 27,0 | 25 | - | - |
| ZT01004 | SPZ100-04 | 4 | 100 | 104 | 8 | 1610 | 42 | - | 52 | 71 | 27,0 | 25 | - | - |
| ZT01064 | SPZ106-04 | 4 | 106 | 110 | 8 | 1610 | 42 | - | 52 | 76 | 27,0 | 25 | - | - |
| ZT01124 | SPZ112-04 | 4 | 112 | 116 | 8 | 2012 | 50 | - | 52 | 83 | 20,0 | 32 | - | - |
| ZT01184 | SPZ118-04 | 4 | 118 | 122 | 8 | 2012 | 50 | - | 52 | 90 | 20,0 | 32 | - | - |
| ZT01254 | SPZ125-04 | 4 | 125 | 129 | 2 | 2012 | 50 | - | 52 | 96 | - | 32 | 20,0 | - |
| ZT01324 | SPZ132-04 | 4 | 132 | 136 | 2 | 2012 | 50 | - | 52 | 103 | - | 32 | 20,0 | - |
| ZT01404 | SPZ140-04 | 4 | 140 | 144 | 2 | 2012 | 50 | - | 52 | 111 | - | 32 | 20,0 | - |
| ZT01504 | SPZ150-04 | 4 | 150 | 154 | 2 | 2517 | 60 | - | 52 | 121 | - | 45 | 7,0 | - |
| ZT01604 | SPZ160-04 | 4 | 160 | 164 | 2 | 2517 | 60 | - | 52 | 131 | - | 45 | 7,0 | - |
| ZT01704 | SPZ170-04 | 4 | 170 | 174 | 2 | 2517 | 60 | - | 52 | 141 | - | 45 | 7,0 | - |
| ZT01804 | SPZ180-04 | 4 | 180 | 184 | 2 | 2517 | 60 | - | 52 | 151 | - | 45 | 7,0 | - |
| ZT01904 | SPZ190-04 | 4 | 190 | 194 | 3 | 2517 | 60 | - | 52 | 161 | 3,5 | 45 | 3,5 | - |
| ZT02004 | SPZ200-04 | 4 | 200 | 204 | 6 | 2517 | 60 | 8 | 52 | 171 | 3,5 | 45 | 3,5 | 124 |
| ZT02244 | SPZ224-04 | 4 | 224 | 228 | 6 | 2517 | 60 | 14 | 52 | 195 | 3,5 | 45 | 3,5 | 124 |
| ZT02504 | SPZ250-04 | 4 | 250 | 254 | 6 | 2517 | 60 | 12 | 52 | 221 | 3,5 | 45 | 3,5 | 124 |
| ZT02804 | SPZ280-04 | 4 | 280 | 284 | 6 | 2517 | 60 | 14 | 52 | 251 | 3,5 | 45 | 3,5 | 124 |
| ZT03154 | SPZ315-04 | 4 | 315 | 319 | 5 | 2517 | 60 | - | 52 | 286 | 3,5 | 45 | 3,5 | 124 |
| ZT03554 | SPZ355-04 | 4 | 355 | 359 | 5 | 2517 | 60 | - | 52 | 326 | 3,5 | 45 | 3,5 | 124 |
| ZT04004 | SPZ400-04 | 4 | 400 | 404 | 5 | 2517 | 60 | - | 52 | 371 | 3,5 | 45 | 3,5 | 124 |
| ZT04504 | SPZ450-04 | 4 | 450 | 454 | 5 | 3020 | 75 | - | 52 | 421 | 0,5 | 51 | 0,5 | 146 |
| ZT05004 | SPZ500-04 | 4 | 500 | 504 | 5 | 3020 | 75 | - | 52 | 471 | 0,5 | 51 | 0,5 | 146 |
| ZT06304 | SPZ630-04 | 4 | 630 | 634 | 4 | 3030 | 75 | - | 52 | 601 | 12,0 | 76 | 12,0 | 146 |
| ZT08004 | SPZ800-04 | 4 | 800 | 804 | 4 | 3030 | 75 | - | 52 | 771 | 12,0 | 76 | 12,0 | 146 |

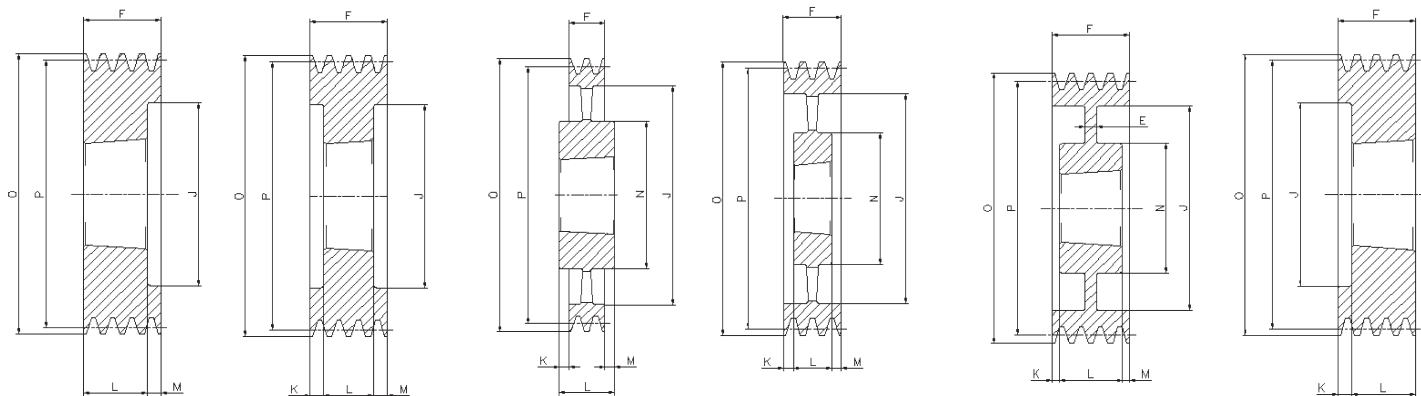

2

3

4

5

6

8

SPZ/5

| Cod. interno Internal code Intern Code Code interne Código interno | Tipo Type Typ Type Tipo | Gole Grooves Rillen Gorges Canales | P | O | Forma Form Forme Forme Forma | Bussola Bush Buchse Moyeu Casquillo | ∅ MAX | E | F | J | K | L | M | N |
|--|-------------------------------------|--|-----|-----|--|---|----------|----|----|-----|------|----|------|-----|
| ZT00855 | SPZ 85-05 | 5 | 85 | 89 | 8 | 1610 | 42 | - | 64 | 60 | 39,0 | 25 | - | - |
| ZT00905 | SPZ 90-05 | 5 | 90 | 94 | 8 | 1610 | 42 | - | 64 | 61 | 39,0 | 25 | - | - |
| ZT00955 | SPZ 95-05 | 5 | 95 | 99 | 8 | 1610 | 42 | - | 64 | 66 | 39,0 | 25 | - | - |
| ZT01005 | SPZ100-05 | 5 | 100 | 104 | 8 | 2012 | 50 | - | 64 | 71 | 32,0 | 32 | - | - |
| ZT01065 | SPZ106-05 | 5 | 106 | 110 | 8 | 2012 | 50 | - | 64 | 76 | 32,0 | 32 | - | - |
| ZT01125 | SPZ112-05 | 5 | 112 | 116 | 8 | 2012 | 50 | - | 64 | 83 | 32,0 | 32 | - | - |
| ZT01185 | SPZ118-05 | 5 | 118 | 122 | 8 | 2012 | 50 | - | 64 | 90 | 32,0 | 32 | - | - |
| ZT01255 | SPZ125-05 | 5 | 125 | 129 | 8 | 2012 | 50 | - | 64 | 96 | 32,0 | 32 | - | - |
| ZT01325 | SPZ132-05 | 5 | 132 | 136 | 8 | 2517 | 60 | - | 64 | 103 | 19,0 | 45 | 19,0 | - |
| ZT01405 | SPZ140-05 | 5 | 140 | 144 | 2 | 2517 | 60 | - | 64 | 111 | - | 45 | 19,0 | - |
| ZT01505 | SPZ150-05 | 5 | 150 | 154 | 2 | 2517 | 60 | - | 64 | 121 | - | 45 | 19,0 | - |
| ZT01605 | SPZ160-05 | 5 | 160 | 164 | 2 | 2517 | 60 | - | 64 | 131 | - | 45 | 19,0 | - |
| ZT01705 | SPZ170-05 | 5 | 170 | 174 | 2 | 2517 | 60 | - | 64 | 141 | - | 45 | 19,0 | - |
| ZT01805 | SPZ180-05 | 5 | 180 | 184 | 2 | 2517 | 60 | - | 64 | 151 | - | 45 | 19,0 | - |
| ZT01905 | SPZ190-05 | 5 | 190 | 194 | 3 | 2517 | 60 | - | 64 | 161 | 9,5 | 45 | 9,5 | - |
| ZT02005 | SPZ200-05 | 5 | 200 | 204 | 3 | 2517 | 60 | - | 64 | 171 | 9,5 | 45 | 9,5 | - |
| ZT02245 | SPZ224-05 | 5 | 224 | 228 | 6 | 2517 | 60 | 20 | 64 | 195 | 9,5 | 45 | 9,5 | 124 |
| ZT02505 | SPZ250-05 | 5 | 250 | 254 | 6 | 2517 | 60 | 16 | 64 | 221 | 9,5 | 45 | 9,5 | 124 |
| ZT02805 | SPZ280-05 | 5 | 280 | 284 | 6 | 2517 | 60 | 15 | 64 | 251 | 9,5 | 45 | 9,5 | 124 |
| ZT03155 | SPZ315-05 | 5 | 315 | 319 | 5 | 2517 | 60 | - | 64 | 286 | 9,5 | 45 | 9,5 | 124 |
| ZT03555 | SPZ355-05 | 5 | 355 | 359 | 5 | 2517 | 60 | - | 64 | 326 | 9,5 | 45 | 9,5 | 124 |
| ZT04005 | SPZ400-05 | 5 | 400 | 404 | 5 | 3020 | 75 | - | 64 | 371 | 6,5 | 51 | 6,5 | 146 |
| ZT04505 | SPZ450-05 | 5 | 450 | 454 | 5 | 3020 | 75 | - | 64 | 421 | 6,5 | 51 | 6,5 | 146 |
| ZT05005 | SPZ500-05 | 5 | 500 | 504 | 4 | 3030 | 75 | - | 64 | 471 | 6,0 | 76 | 6,0 | 146 |
| ZT06305 | SPZ630-05 | 5 | 630 | 634 | 4 | 3030 | 75 | - | 64 | 601 | 6,0 | 76 | 6,0 | 146 |
| ZT08005 | SPZ800-05 | 5 | 800 | 804 | 4 | 3535 | 90 | - | 64 | 771 | 12,5 | 89 | 12,5 | 178 |

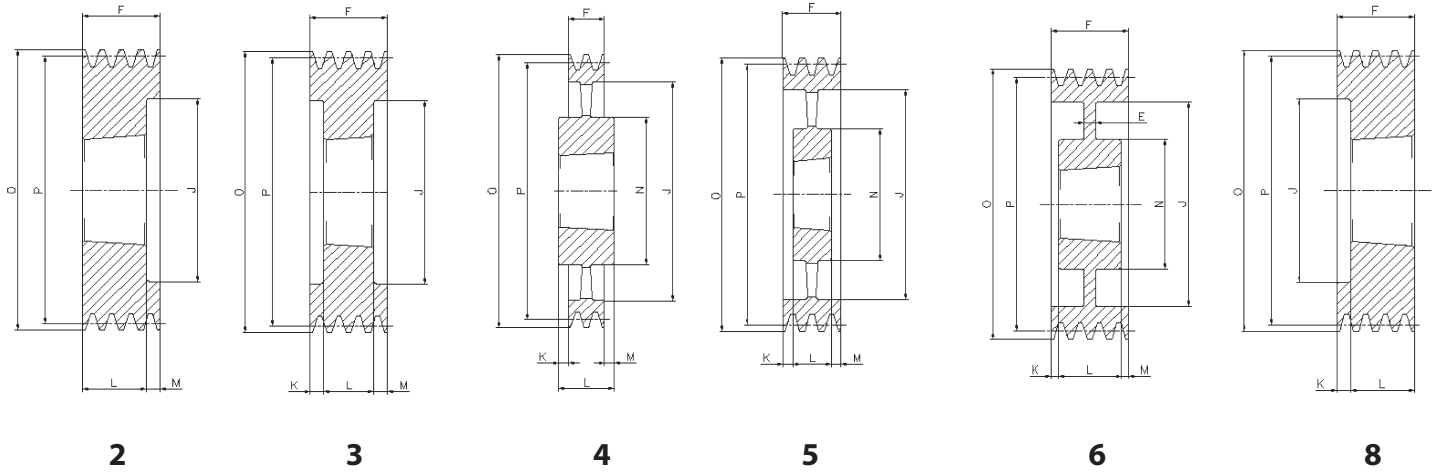

SPZ/6

| Cod. interno Internal code Interne Code Code interne Código interno | Tipo Type Typ Type Tipo | Gole Grooves Rillen Gorges Canales | P | O | Forma Form Forme Forme Forma | Bussola Bush Buchse Moyeu Casquillo | ∅ MAX | E | F | J | K | L | M | N |
|---|-------------------------------------|--|------------|-----|--|---|----------|----|----|-----|------|----|------|-----|
| ZT00906 | SPZ 90-06 | 6 | 90 | 94 | 8 | 1610 | 42 | - | 76 | 61 | 51,0 | 25 | - | - |
| ZT00956 | SPZ 95-06 | 6 | 95 | 99 | 8 | 1610 | 42 | - | 76 | 66 | 51,0 | 25 | - | - |
| ZT01006 | SPZ100-06 | 6 | 100 | 104 | 8 | 2012 | 50 | - | 76 | 71 | 44,0 | 32 | - | - |
| ZT01066 | SPZ106-06 | 6 | 106 | 110 | 8 | 2012 | 50 | - | 76 | 76 | 44,0 | 32 | - | - |
| ZT01126 | SPZ112-06 | 6 | 112 | 116 | 8 | 2012 | 50 | - | 76 | 83 | 44,0 | 32 | - | - |
| ZT01186 | SPZ118-06 | 6 | 118 | 122 | 8 | 2517 | 60 | - | 76 | 90 | 31,0 | 45 | - | - |
| ZT01256 | SPZ125-06 | 6 | 125 | 129 | 8 | 2517 | 60 | - | 76 | 96 | 31,0 | 45 | - | - |
| ZT01326 | SPZ132-06 | 6 | 132 | 136 | 8 | 2517 | 60 | - | 76 | 103 | 31,0 | 45 | - | - |
| ZT01406 | SPZ140-06 | 6 | 140 | 144 | 2 | 2517 | 60 | - | 76 | 111 | - | 45 | 31,0 | - |
| ZT01506 | SPZ150-06 | 6 | 150 | 154 | 2 | 2517 | 60 | - | 76 | 121 | - | 45 | 31,0 | - |
| ZT01606 | SPZ160-06 | 6 | 160 | 164 | 2 | 2517 | 60 | - | 76 | 131 | - | 45 | 31,0 | - |
| ZT01706 | SPZ170-06 | 6 | 170 | 174 | 2 | 2517 | 60 | - | 76 | 141 | - | 45 | 31,0 | - |
| ZT01806 | SPZ180-06 | 6 | 180 | 184 | 3 | 2517 | 60 | - | 76 | 151 | 15,5 | 45 | 15,5 | - |
| ZT01906 | SPZ190-06 | 6 | 190 | 194 | 3 | 2517 | 60 | - | 76 | 161 | 15,5 | 45 | 15,5 | 124 |
| ZT02006 | SPZ200-06 | 6 | 200 | 204 | 3 | 2517 | 60 | - | 76 | 171 | 15,5 | 45 | 15,5 | 124 |
| ZT02246 | SPZ224-06 | 6 | 224 | 228 | 6 | 2517 | 60 | 26 | 76 | 195 | 15,5 | 45 | 15,5 | 124 |
| ZT02506 | SPZ250-06 | 6 | 250 | 254 | 6 | 2517 | 60 | 26 | 76 | 221 | 15,5 | 45 | 15,5 | 124 |
| ZT02806 | SPZ280-06 | 6 | 280 | 284 | 6 | 2517 | 60 | 15 | 76 | 251 | 15,5 | 45 | 15,5 | 124 |
| ZT03156 | SPZ315-06 | 6 | 315 | 319 | 6 | 2517 | 60 | 15 | 76 | 286 | 15,5 | 45 | 15,5 | 124 |
| ZT03556 | SPZ355-06 | 6 | 355 | 359 | 5 | 2517 | 60 | - | 76 | 326 | 15,5 | 45 | 15,5 | 124 |
| ZT04006 | SPZ400-06 | 6 | 400 | 404 | 5 | 3030 | 75 | - | 76 | 371 | - | 76 | - | 146 |
| ZT04506 | SPZ450-06 | 6 | 450 | 454 | 5 | 3030 | 75 | - | 76 | 421 | - | 76 | - | 146 |
| ZT05006 | SPZ500-06 | 6 | 500 | 504 | 5 | 3030 | 75 | - | 76 | 471 | - | 76 | - | 146 |
| ZT06306 | SPZ630-06 | 6 | 630 | 634 | 4 | 3535 | 90 | - | 76 | 601 | 6,5 | 89 | 6,5 | 175 |
| ZT08006 | SPZ800-06 | 6 | 800 | 804 | 4 | 3535 | 90 | - | 76 | 771 | 6,5 | 89 | 6,5 | 178 |

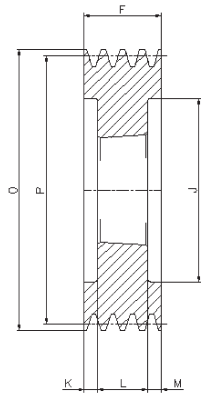

3

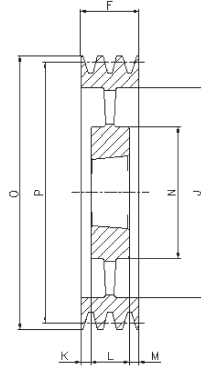

5

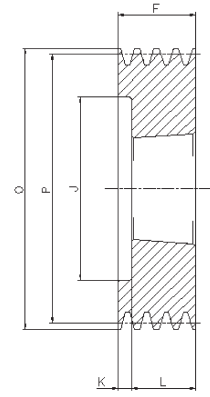

8

SPZ/8

| Cod. interno Internal code Interne Code Code interne Código interno | Tipo Type Typ Type Tipo | Gole Grooves Rillen Gorges Canales | P | O | Forma Form Forme Forme Forma | Bussola Bush Buchse Moyeu Casquillo | ∅ MAX | E | F | J | K | L | M | N |
|---|-------------------------------------|--|-----|-----|--|---|----------|----|-----|-----|------|----|------|-----|
| ZT01408 | SPZ140-08 | 8 | 140 | 144 | 3 | 2517 | 60 | - | 100 | 111 | 27,5 | 45 | 27,5 | - |
| ZT01508 | SPZ150-08 | 8 | 150 | 154 | 3 | 2517 | 60 | - | 100 | 121 | 27,5 | 45 | 27,5 | - |
| ZT01608 | SPZ160-08 | 8 | 160 | 164 | 3 | 2517 | 60 | - | 100 | 131 | 27,5 | 45 | 27,5 | - |
| ZT01808 | SPZ180-08 | 8 | 180 | 184 | 3 | 2517 | 60 | - | 100 | 151 | 27,5 | 45 | 27,5 | - |
| ZT02008 | SPZ200-08 | 8 | 200 | 204 | 3 | 3020 | 75 | - | 100 | 171 | 24,5 | 51 | 24,5 | - |
| ZT02248 | SPZ224-08 | 8 | 224 | 228 | 3 | 3020 | 75 | - | 100 | 195 | 24,5 | 51 | 24,5 | - |
| ZT02508 | SPZ250-08 | 8 | 250 | 254 | 6 | 3020 | 75 | 20 | 100 | 221 | 24,5 | 51 | 24,5 | 146 |
| ZT02808 | SPZ280-08 | 8 | 280 | 284 | 6 | 3020 | 75 | 20 | 100 | 251 | 24,5 | 51 | 24,5 | 146 |
| ZT03558 | SPZ355-08 | 8 | 355 | 359 | 5 | 3030 | 75 | - | 100 | 326 | 12,5 | 76 | 12,5 | 146 |
| ZT04008 | SPZ400-08 | 8 | 400 | 404 | 5 | 3030 | 75 | - | 100 | 371 | 12,5 | 76 | 12,5 | 146 |
| ZT04508 | SPZ450-08 | 8 | 450 | 454 | 5 | 3535 | 90 | - | 100 | 421 | 5,5 | 89 | 5,5 | 175 |

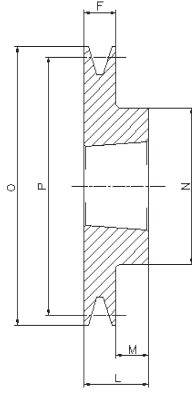

1

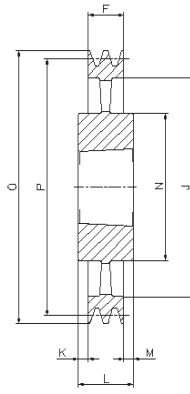

4

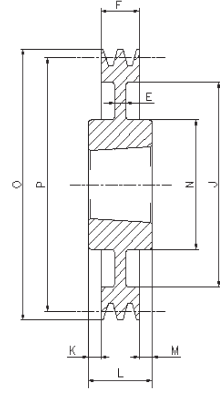

7

SPA/1

| Cod. interno Internal code Intern Code Code interne Código interno | Tipo Type Typ Type Tipo | Gole Grooves Rillen Gorges Canales | P | O | Forma Form Forme Forme Forma | Bussola Bush Buchse Moyeu Casquillo | Ø MAX | E | F | J | K | L | M | N |
|--|-------------------------------------|--|------------|-------|--|---|----------|----|----|-----|---|----|----|-----|
| AT00631 | SPA 63-01 | 1 | 63 | 68,5 | 1 | 1008 | 25 | - | 20 | - | - | 22 | 2 | 56 |
| AT00671 | SPA 67-01 | 1 | 67 | 72,5 | 1 | 1108 | 28 | - | 20 | - | - | 22 | 2 | 56 |
| AT00711 | SPA 71-01 | 1 | 71 | 76,5 | 1 | 1108 | 28 | - | 20 | - | - | 22 | 2 | 60 |
| AT00751 | SPA 75-01 | 1 | 75 | 80,5 | 1 | 1108 | 28 | - | 20 | - | - | 22 | 2 | 56 |
| AT00801 | SPA 80-01 | 1 | 80 | 85,5 | 1 | 1210 | 32 | - | 20 | - | - | 25 | 5 | 75 |
| AT00851 | SPA 85-01 | 1 | 85 | 90,5 | 1 | 1210 | 32 | - | 20 | - | - | 25 | 5 | 80 |
| AT00901 | SPA 90-01 | 1 | 90 | 95,5 | 1 | 1210 | 32 | - | 20 | - | - | 25 | 5 | 80 |
| AT00951 | SPA 95-01 | 1 | 95 | 100,5 | 1 | 1210 | 32 | - | 20 | - | - | 25 | 5 | 85 |
| AT01001 | SPA100-01 | 1 | 100 | 105,5 | 1 | 1610 | 42 | - | 20 | - | - | 25 | 5 | 85 |
| AT01061 | SPA106-01 | 1 | 106 | 111,5 | 1 | 1610 | 42 | - | 20 | - | - | 25 | 5 | 92 |
| AT01121 | SPA112-01 | 1 | 112 | 117,5 | 1 | 1610 | 42 | - | 20 | - | - | 25 | 5 | 92 |
| AT01181 | SPA118-01 | 1 | 118 | 123,5 | 1 | 1610 | 42 | - | 20 | - | - | 25 | 5 | 92 |
| AT01251 | SPA125-01 | 1 | 125 | 130,5 | 1 | 1610 | 42 | - | 20 | - | - | 25 | 5 | 92 |
| AT01321 | SPA132-01 | 1 | 132 | 137,5 | 1 | 1610 | 42 | - | 20 | - | - | 25 | 5 | 92 |
| AT01401 | SPA140-01 | 1 | 140 | 145,5 | 1 | 1610 | 42 | - | 20 | - | - | 25 | 5 | 92 |
| AT01501 | SPA150-01 | 1 | 150 | 155,5 | 1 | 1610 | 42 | - | 20 | - | - | 25 | 5 | 92 |
| AT01601 | SPA160-01 | 1 | 160 | 165,5 | 1 | 1610 | 42 | - | 20 | - | - | 25 | 5 | 92 |
| AT01701 | SPA170-01 | 1 | 170 | 175,5 | 1 | 1610 | 42 | - | 20 | - | - | 25 | 5 | 92 |
| AT01801 | SPA180-01 | 1 | 180 | 185,5 | 7 | 1610 | 42 | 6 | 20 | 145 | - | 25 | 5 | 92 |
| AT01901 | SPA190-01 | 1 | 190 | 195,5 | 7 | 1610 | 42 | 6 | 20 | 156 | - | 25 | 5 | 92 |
| AT02001 | SPA200-01 | 1 | 200 | 205,5 | 7 | 2012 | 50 | 6 | 20 | 165 | - | 32 | 12 | 108 |
| AT02121 | SPA212-01 | 1 | 212 | 217,5 | 7 | 2012 | 50 | 10 | 20 | 177 | - | 32 | 12 | 110 |
| AT02241 | SPA224-01 | 1 | 224 | 229,5 | 7 | 2012 | 50 | 10 | 20 | 189 | - | 32 | 12 | 112 |
| AT02361 | SPA236-01 | 1 | 236 | 241,5 | 7 | 2012 | 50 | 10 | 20 | 202 | - | 32 | 12 | 112 |
| AT02501 | SPA250-01 | 1 | 250 | 255,5 | 7 | 2012 | 50 | 10 | 20 | 215 | 6 | 32 | 6 | 112 |
| AT02801 | SPA280-01 | 1 | 280 | 285,5 | 7 | 2012 | 50 | 10 | 20 | 245 | - | 32 | 12 | 112 |
| AT03001 | SPA300-01 | 1 | 300 | 305,5 | 7 | 2012 | 50 | 12 | 20 | 265 | - | 32 | 12 | 112 |
| AT03151 | SPA315-01 | 1 | 315 | 320,5 | 7 | 2012 | 50 | 12 | 20 | 280 | - | 32 | 12 | 112 |
| AT03551 | SPA355-01 | 1 | 355 | 360,5 | 4 | 2012 | 50 | - | 20 | 320 | - | 32 | 12 | 112 |
| AT04001 | SPA400-01 | 1 | 400 | 405,5 | 4 | 2012 | 50 | - | 20 | 365 | - | 32 | 12 | 112 |
| AT04501 | SPA450-01 | 1 | 450 | 455,5 | 4 | 2012 | 50 | - | 20 | 415 | - | 32 | 12 | 112 |
| AT05001 | SPA500-01 | 1 | 500 | 505,5 | 4 | 2517 | 60 | - | 20 | 465 | - | 45 | 25 | 124 |
| AT06301 | SPA630-01 | 1 | 630 | 635,5 | 4 | 2517 | 60 | - | 20 | 595 | - | 45 | 25 | 124 |

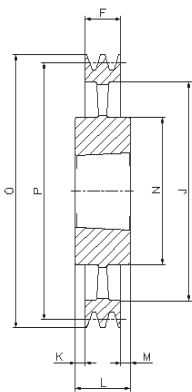

4

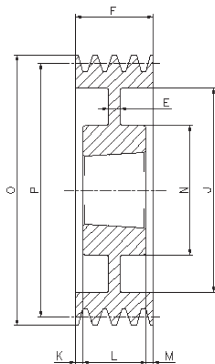

6

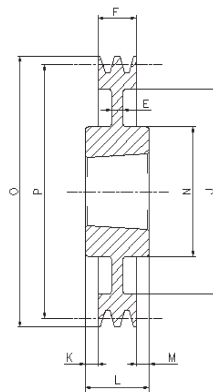

7

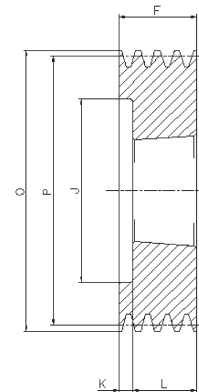

8

SPA/2

| Cod. interno Internal code Intern Code Code interne Còdigo interno | Tipo Type Typ Type Tipo | Gole Grooves Rillen Gorges Canales | P | O | Forma Form Forme Forme Forma | Bussola Bush Buchse Moyeu Casquillo | ∅ MAX | E | F | J | K | L | M | N |
|--|-------------------------------------|--|-----|-------|--|---|----------|----|----|-------|------|----|------|-----|
| AT00632 | SPA 63-02 | 2 | 63 | 68,5 | 8 | 1008 | 28 | - | 35 | 32,5 | 13,0 | 22 | - | - |
| AT00672 | SPA 67-02 | 2 | 67 | 72,5 | 8 | 1108 | 28 | - | 35 | 37,0 | 13,0 | 22 | - | - |
| AT00712 | SPA 71-02 | 2 | 71 | 76,5 | 8 | 1108 | 28 | - | 35 | 40,0 | 13,0 | 22 | - | - |
| AT00752 | SPA 75-02 | 2 | 75 | 80,5 | 8 | 1108 | 28 | - | 35 | 44,0 | 13,0 | 22 | - | - |
| AT00802 | SPA 80-02 | 2 | 80 | 85,5 | 8 | 1210 | 32 | - | 35 | 50,0 | 10,0 | 25 | - | - |
| AT00852 | SPA 85-02 | 2 | 85 | 90,5 | 8 | 1210 | 32 | - | 35 | 55,0 | 10,0 | 25 | - | - |
| AT00902 | SPA 90-02 | 2 | 90 | 95,5 | 8 | 1610 | 42 | - | 35 | 59,0 | 10,0 | 25 | - | - |
| AT00952 | SPA 95-02 | 2 | 95 | 100,5 | 8 | 1610 | 42 | - | 35 | 63,0 | 10,0 | 25 | - | - |
| AT01002 | SPA100-02 | 2 | 100 | 105,5 | 8 | 1610 | 42 | - | 35 | 66,0 | 10,0 | 25 | - | - |
| AT01062 | SPA106-02 | 2 | 106 | 111,5 | 8 | 1610 | 42 | - | 35 | 72,0 | 10,0 | 25 | - | - |
| AT01122 | SPA112-02 | 2 | 112 | 117,5 | 8 | 1610 | 42 | - | 35 | 78,0 | 10,0 | 25 | - | - |
| AT01182 | SPA118-02 | 2 | 118 | 123,5 | 8 | 1610 | 42 | - | 35 | 84,0 | 10,0 | 25 | - | - |
| AT01252 | SPA125-02 | 2 | 125 | 130,5 | 8 | 1610 | 42 | - | 35 | 91,0 | 10,0 | 25 | - | - |
| AT01322 | SPA132-02 | 2 | 132 | 137,5 | 8 | 2012 | 50 | - | 35 | 98,0 | 3,0 | 32 | - | - |
| AT01402 | SPA140-02 | 2 | 140 | 145,5 | 8 | 2012 | 50 | - | 35 | 106,0 | 3,0 | 32 | - | - |
| AT01502 | SPA150-02 | 2 | 150 | 155,5 | 8 | 2012 | 50 | - | 35 | 116,0 | 3,0 | 32 | - | - |
| AT01602 | SPA160-02 | 2 | 160 | 165,5 | 8 | 2012 | 50 | - | 35 | 125,0 | 3,0 | 32 | - | - |
| AT01702 | SPA170-02 | 2 | 170 | 175,5 | 8 | 2012 | 50 | - | 35 | 135,0 | 3,0 | 32 | - | - |
| AT01802 | SPA180-02 | 2 | 180 | 185,5 | 6 | 2012 | 50 | 10 | 35 | 146,0 | 1,5 | 32 | 1,5 | 108 |
| AT01902 | SPA190-02 | 2 | 190 | 195,5 | 6 | 2012 | 50 | 10 | 35 | 156,0 | 1,5 | 32 | 1,5 | 108 |
| AT02002 | SPA200-02 | 2 | 200 | 205,5 | 7 | 2517 | 60 | 10 | 35 | 165,0 | 5,0 | 45 | 5,0 | 123 |
| AT02122 | SPA212-02 | 2 | 212 | 217,5 | 7 | 2517 | 60 | 18 | 35 | 177,0 | 5,0 | 45 | 5,0 | 123 |
| AT02242 | SPA224-02 | 2 | 224 | 229,5 | 7 | 2517 | 60 | 18 | 35 | 189,0 | - | 45 | 10,0 | 124 |
| AT02362 | SPA236-02 | 2 | 236 | 241,5 | 7 | 2517 | 60 | 12 | 35 | 202,0 | - | 45 | 10,0 | 124 |
| AT02502 | SPA250-02 | 2 | 250 | 255,5 | 7 | 2517 | 60 | 12 | 35 | 215,0 | 5,0 | 45 | 5,0 | 124 |
| AT02802 | SPA280-02 | 2 | 280 | 285,5 | 7 | 2517 | 60 | 12 | 35 | 245,0 | - | 45 | 10,0 | 124 |
| AT03002 | SPA300-02 | 2 | 300 | 305,5 | 7 | 2517 | 60 | 12 | 35 | 265,0 | - | 45 | 10,0 | 124 |
| AT03152 | SPA315-02 | 2 | 315 | 320,5 | 7 | 2517 | 60 | 12 | 35 | 280,0 | - | 45 | 10,0 | 124 |
| AT03552 | SPA355-02 | 2 | 355 | 360,5 | 4 | 2517 | 60 | - | 35 | 320,0 | - | 45 | 10,0 | 124 |
| AT04002 | SPA400-02 | 2 | 400 | 405,5 | 4 | 2517 | 60 | - | 35 | 365,0 | - | 45 | 10,0 | 124 |
| AT04502 | SPA450-02 | 2 | 450 | 455,5 | 4 | 2517 | 60 | - | 35 | 465,0 | - | 45 | 10,0 | 124 |
| AT05002 | SPA500-02 | 2 | 500 | 505,5 | 4 | 2517 | 60 | - | 35 | 525,0 | - | 45 | 10,0 | 125 |
| AT06302 | SPA630-02 | 2 | 630 | 635,5 | 4 | 3020 | 75 | - | 35 | 595,0 | 8,0 | 51 | 18,0 | 159 |

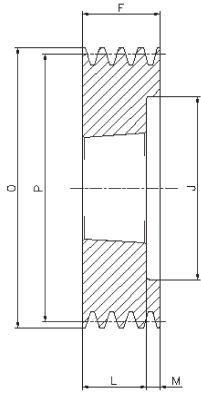

2

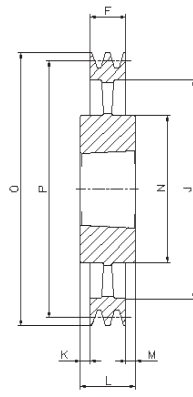

4

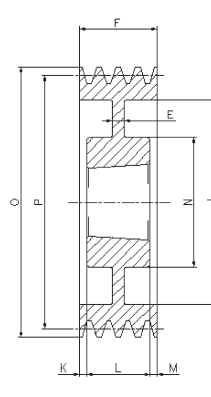

6

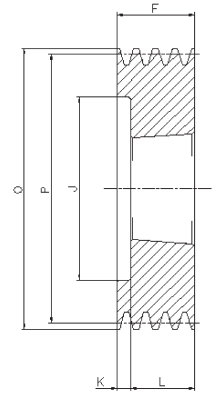

8

SPA/3

| Cod. interno Internal code Interier Code Code interne Código interno | Tipo Type Typ Type Tipo | Gole Grooves Rillen Gorges Canales | P | O | Forma Form Forme Forme Forma | Bussola Bush Buchse Moyeu Casquillo | ∅ MAX | E | F | J | K | L | M | N |
|--|-------------------------------------|--|-------------|--------|--|---|----------|----|----|-----|------|----|------|-----|
| AT00713 | SPA 71-03 | 3 | 71 | 76,5 | 8 | 1108 | 28 | - | 50 | 40 | 28,0 | 22 | - | - |
| AT00753 | SPA 75-03 | 3 | 75 | 80,5 | 8 | 1108 | 28 | - | 50 | 44 | 28,0 | 22 | - | - |
| AT00803 | SPA 80-03 | 3 | 80 | 85,5 | 8 | 1210 | 32 | - | 50 | 50 | 25,0 | 25 | - | - |
| AT00853 | SPA 85-03 | 3 | 85 | 90,5 | 8 | 1210 | 32 | - | 50 | 55 | 25,0 | 25 | - | - |
| AT00903 | SPA 90-03 | 3 | 90 | 95,5 | 8 | 1610 | 42 | - | 50 | 59 | 25,0 | 25 | - | - |
| AT00953 | SPA 95-03 | 3 | 95 | 100,5 | 8 | 1610 | 42 | - | 50 | 63 | 25,0 | 25 | - | - |
| AT01003 | SPA100-03 | 3 | 100 | 105,5 | 2 | 1610 | 42 | - | 50 | 66 | - | 25 | 25,0 | - |
| AT01063 | SPA106-03 | 3 | 106 | 111,5 | 2 | 1610 | 42 | - | 50 | 72 | - | 25 | 25,0 | - |
| AT01123 | SPA112-03 | 3 | 112 | 117,5 | 8 | 2012 | 50 | - | 50 | 78 | 18,0 | 32 | - | - |
| AT01183 | SPA118-03 | 3 | 118 | 123,5 | 2 | 2012 | 50 | - | 50 | 84 | - | 32 | 18,0 | - |
| AT01253 | SPA125-03 | 3 | 125 | 130,5 | 2 | 2012 | 50 | - | 50 | 91 | - | 32 | 18,0 | - |
| AT01323 | SPA132-03 | 3 | 132 | 137,5 | 2 | 2012 | 50 | - | 50 | 98 | - | 32 | 18,0 | - |
| AT01403 | SPA140-03 | 3 | 140 | 145,5 | 8 | 2517 | 60 | - | 50 | 106 | 5,0 | 45 | - | - |
| AT01503 | SPA150-03 | 3 | 150 | 155,5 | 8 | 2517 | 60 | - | 50 | 116 | 5,0 | 45 | - | - |
| AT01603 | SPA160-03 | 3 | 160 | 165,5 | 8 | 2517 | 60 | - | 50 | 125 | 5,0 | 45 | - | - |
| AT01703 | SPA170-03 | 3 | 170 | 175,5 | 8 | 2517 | 60 | - | 50 | 135 | 5,0 | 45 | - | - |
| AT01803 | SPA180-03 | 3 | 180 | 185,5 | 8 | 2517 | 60 | - | 50 | 146 | 5,0 | 45 | - | - |
| AT01903 | SPA190-03 | 3 | 190 | 195,5 | 8 | 2517 | 60 | - | 50 | 156 | 5,0 | 45 | - | - |
| AT02003 | SPA200-03 | 3 | 200 | 205,5 | 6 | 2517 | 60 | 20 | 50 | 165 | 2,5 | 45 | 2,5 | 123 |
| AT02123 | SPA212-03 | 3 | 212 | 217,5 | 6 | 2517 | 60 | 20 | 50 | 177 | 2,5 | 45 | 2,5 | 123 |
| AT02243 | SPA224-03 | 3 | 224 | 229,5 | 6 | 2517 | 60 | 20 | 50 | 189 | 2,5 | 45 | 2,5 | 124 |
| AT02363 | SPA236-03 | 3 | 236 | 241,5 | 6 | 2517 | 60 | 20 | 50 | 202 | 2,5 | 45 | 2,5 | 124 |
| AT02503 | SPA250-03 | 3 | 250 | 255,5 | 6 | 2517 | 60 | 20 | 50 | 215 | 2,5 | 45 | 2,5 | 124 |
| AT02803 | SPA280-03 | 3 | 280 | 285,5 | 6 | 2517 | 60 | 20 | 50 | 245 | 2,5 | 45 | 2,5 | 124 |
| AT03003 | SPA300-03 | 3 | 300 | 305,5 | 4 | 3020 | 75 | - | 50 | 265 | 0,5 | 51 | 0,5 | 146 |
| AT03153 | SPA315-03 | 3 | 315 | 320,5 | 4 | 3020 | 75 | - | 50 | 280 | 0,5 | 51 | 0,5 | 159 |
| AT03553 | SPA355-03 | 3 | 355 | 360,5 | 4 | 3020 | 75 | - | 50 | 320 | 0,5 | 51 | 0,5 | 159 |
| AT04003 | SPA400-03 | 3 | 400 | 405,5 | 4 | 3020 | 75 | - | 50 | 365 | - | 51 | 1,0 | 159 |
| AT04503 | SPA450-03 | 3 | 450 | 455,5 | 4 | 3020 | 75 | - | 50 | 415 | - | 51 | 1,0 | 159 |
| AT05003 | SPA500-03 | 3 | 500 | 505,5 | 4 | 3020 | 75 | - | 50 | 465 | - | 51 | 1,0 | 159 |
| AT05603 | SPA560-03 | 3 | 560 | 565,5 | 4 | 3020 | 75 | - | 50 | 525 | - | 51 | 1,0 | 150 |
| AT06303 | SPA630-03 | 3 | 630 | 635,5 | 4 | 3020 | 75 | - | 50 | 595 | - | 51 | 1,0 | 150 |
| AT08003 | SPA800-03 | 3 | 800 | 805,5 | 4 | 3535 | 90 | - | 50 | 765 | 19,5 | 89 | 19,5 | 175 |
| AT10003 | SPA1000-03 | 3 | 1000 | 1005,5 | 4 | 3535 | 90 | - | 50 | 965 | 19,5 | 89 | 19,5 | 175 |

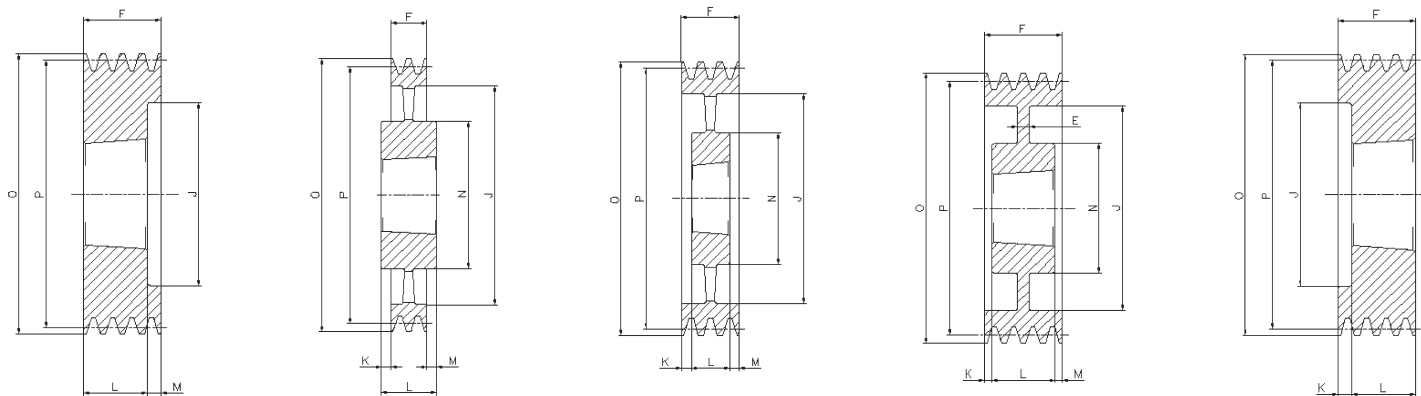

2

4

5

6

8

SPA/4

| Cod. interno Internal code Code interne Código interno | Tipo Type Typ Type Tipo | Gole Grooves Rillen Gorges Canales | P | O | Forma Forme Forme Forme Forma | Bussola Buchse Moyeu Casquillo | Ø MAX | E | F | J | K | L | M | N |
|---|-------------------------------------|--|------|--------|---|---|----------|----|----|-----|------|-----|------|-----|
| AT00804 | SPA 80-04 | 4 | 80 | 85,5 | 8 | 1215 | 28 | - | 65 | 49 | 27 | 38 | - | - |
| AT00904 | SPA 90-04 | 4 | 90 | 95,5 | 8 | 1615 | 42 | - | 65 | 59 | 27,0 | 38 | - | - |
| AT00954 | SPA 95-04 | 4 | 95 | 100,5 | 8 | 1615 | 42 | - | 65 | 63 | 27,0 | 38 | - | - |
| AT01004 | SPA100-04 | 4 | 100 | 105,5 | 2 | 1615 | 42 | - | 65 | 66 | - | 38 | 27,0 | - |
| AT01064 | SPA106-04 | 4 | 106 | 111,5 | 8 | 2012 | 50 | - | 65 | 72 | 33,0 | 32 | - | - |
| AT01124 | SPA112-04 | 4 | 112 | 117,5 | 8 | 2012 | 50 | - | 65 | 78 | 33,0 | 32 | - | - |
| AT01184 | SPA118-04 | 4 | 118 | 123,5 | 2 | 2012 | 50 | - | 65 | 84 | - | 32 | 33,0 | - |
| AT01254 | SPA125-04 | 4 | 125 | 130,5 | 2 | 2012 | 50 | - | 65 | 91 | - | 32 | 33,0 | - |
| AT01324 | SPA132-04 | 4 | 132 | 137,5 | 2 | 2517 | 60 | - | 65 | 98 | - | 45 | 20,0 | - |
| AT01404 | SPA140-04 | 4 | 140 | 145,5 | 2 | 2517 | 60 | - | 65 | 106 | - | 45 | 20,0 | - |
| AT01504 | SPA150-04 | 4 | 150 | 155,5 | 2 | 2517 | 60 | - | 65 | 116 | - | 45 | 20,0 | - |
| AT01604 | SPA160-04 | 4 | 160 | 165,5 | 2 | 2517 | 60 | - | 65 | 125 | - | 45 | 20,0 | - |
| AT01704 | SPA170-04 | 4 | 170 | 175,5 | 2 | 2517 | 60 | - | 65 | 135 | - | 45 | 20,0 | - |
| AT01804 | SPA180-04 | 4 | 180 | 185,5 | 2 | 2517 | 60 | - | 65 | 146 | - | 45 | 20,0 | - |
| AT01904 | SPA190-04 | 4 | 190 | 195,5 | 2 | 2517 | 60 | - | 65 | 156 | - | 45 | 20,0 | - |
| AT02004 | SPA200-04 | 4 | 200 | 205,5 | 2 | 3020 | 75 | - | 65 | 165 | - | 51 | 14,0 | - |
| AT02124 | SPA212-04 | 4 | 212 | 217,5 | 2 | 3020 | 75 | - | 65 | 177 | - | 51 | 14,0 | - |
| AT02244 | SPA224-04 | 4 | 224 | 229,5 | 2 | 3020 | 75 | - | 65 | 189 | - | 51 | 14,0 | - |
| AT02364 | SPA236-04 | 4 | 236 | 241,5 | 6 | 3020 | 75 | 25 | 65 | 202 | - | 51 | 14,0 | - |
| AT02504 | SPA250-04 | 4 | 250 | 255,5 | 6 | 3020 | 75 | 20 | 65 | 215 | 7,0 | 51 | 7,0 | 159 |
| AT02804 | SPA280-04 | 4 | 280 | 285,5 | 6 | 3020 | 75 | 25 | 65 | 245 | 7,0 | 51 | 7,0 | 159 |
| AT03004 | SPA300-04 | 4 | 300 | 305,5 | 6 | 3020 | 75 | 25 | 65 | 265 | 7,0 | 51 | 7,0 | 159 |
| AT03154 | SPA315-04 | 4 | 315 | 320,5 | 6 | 3020 | 75 | 25 | 65 | 280 | 7,0 | 51 | 7,0 | 159 |
| AT03554 | SPA355-04 | 4 | 355 | 360,5 | 5 | 3020 | 75 | - | 65 | 320 | 7,0 | 51 | 7,0 | 159 |
| AT04004 | SPA400-04 | 4 | 400 | 405,5 | 5 | 3020 | 75 | - | 65 | 365 | 7,0 | 51 | 7,0 | 159 |
| AT04504 | SPA450-04 | 4 | 450 | 455,5 | 5 | 3020 | 75 | - | 65 | 415 | 7,0 | 51 | 7,0 | 159 |
| AT05004 | SPA500-04 | 4 | 500 | 505,5 | 5 | 3020 | 75 | - | 65 | 465 | 7,0 | 51 | 7,0 | 159 |
| AT05604 | SPA560-04 | 4 | 560 | 565,5 | 4 | 3535 | 90 | - | 65 | 525 | 12,0 | 89 | 12,0 | 175 |
| AT06304 | SPA630-04 | 4 | 630 | 635,5 | 4 | 3535 | 90 | - | 65 | 595 | 12,0 | 89 | 12,0 | 175 |
| AT08004 | SPA800-04 | 4 | 800 | 805,5 | 4 | 3535 | 90 | - | 65 | 765 | 12,0 | 89 | 12,0 | 175 |
| AT10004 | SPA1000-04 | 4 | 1000 | 1005,5 | 4 | 4040 | 100 | - | 65 | 965 | 18,5 | 102 | 18,5 | 210 |

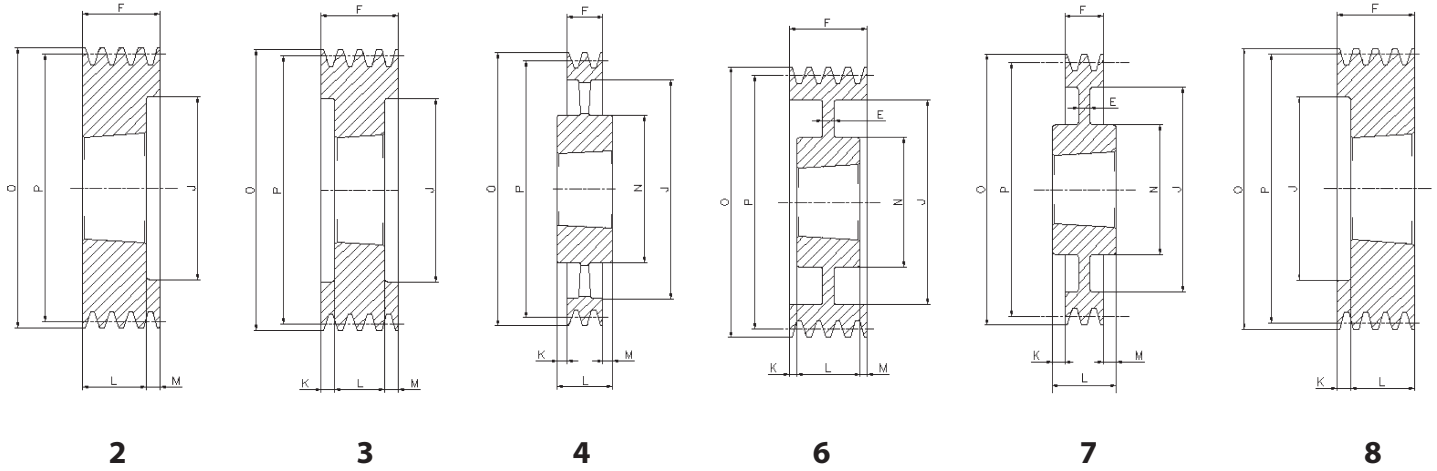

SPA/5

| Cod. interno Internal code Interne Code Code interne Código interno | Tipo Type Typ Type Tipo | Gole Grooves Rillen Gorges Canales | P | O | Forma Form Forme Forme Forma | Bussola Bush Buchse Moyeu Casquillo | ∅ MAX | E | F | J | K | L | M | N |
|---|-------------------------------------|--|------|--------|--|---|----------|----|----|-----|------|-----|------|-----|
| AT01005 | SPA100-05 | 5 | 100 | 105,5 | 2 | 1615 | 42 | - | 80 | 66 | - | 38 | 42,0 | - |
| AT01065 | SPA106-05 | 5 | 106 | 111,5 | 8 | 2012 | 50 | - | 80 | 72 | 48,0 | 32 | - | - |
| AT01125 | SPA112-05 | 5 | 112 | 117,5 | 8 | 2012 | 50 | - | 80 | 78 | 48,0 | 32 | - | - |
| AT01185 | SPA118-05 | 5 | 118 | 123,5 | 2 | 2012 | 50 | - | 80 | 84 | - | 32 | 48,0 | - |
| AT01255 | SPA125-05 | 5 | 125 | 130,5 | 3 | 2012 | 50 | - | 80 | 91 | 24,0 | 32 | 24,0 | - |
| AT01325 | SPA132-05 | 5 | 132 | 137,5 | 3 | 2517 | 60 | - | 80 | 98 | 17,5 | 45 | 17,5 | - |
| AT01405 | SPA140-05 | 5 | 140 | 145,5 | 3 | 2517 | 60 | - | 80 | 106 | 17,5 | 45 | 17,5 | - |
| AT01505 | SPA150-05 | 5 | 150 | 155,5 | 3 | 2517 | 60 | - | 80 | 116 | 17,5 | 45 | 17,5 | - |
| AT01605 | SPA160-05 | 5 | 160 | 165,5 | 3 | 2517 | 60 | - | 80 | 125 | 17,5 | 45 | 17,5 | - |
| AT01705 | SPA170-05 | 5 | 170 | 175,5 | 3 | 2517 | 60 | - | 80 | 135 | 17,5 | 45 | 17,5 | - |
| AT01805 | SPA180-05 | 5 | 180 | 185,5 | 3 | 3020 | 75 | - | 80 | 146 | - | 51 | 29,0 | - |
| AT01905 | SPA190-05 | 5 | 190 | 195,5 | 2 | 3020 | 75 | - | 80 | 156 | 14,5 | 51 | 14,5 | - |
| AT02005 | SPA200-05 | 5 | 200 | 205,5 | 3 | 3020 | 75 | - | 80 | 165 | 14,5 | 51 | 14,5 | - |
| AT02125 | SPA212-05 | 5 | 212 | 217,5 | 2 | 3020 | 75 | - | 80 | 177 | - | 51 | 29,0 | - |
| AT02245 | SPA224-05 | 5 | 224 | 229,5 | 2 | 3020 | 75 | - | 80 | 189 | - | 51 | 29,0 | - |
| AT02365 | SPA236-05 | 5 | 236 | 241,5 | 2 | 3020 | 75 | - | 80 | 202 | - | 51 | 29,0 | - |
| AT02505 | SPA250-05 | 5 | 250 | 255,5 | 6 | 3020 | 75 | 20 | 80 | 215 | 14,5 | 51 | 14,5 | 159 |
| AT02805 | SPA280-05 | 5 | 280 | 285,5 | 7 | 3535 | 90 | 25 | 80 | 245 | 4,5 | 89 | 4,5 | 175 |
| AT03005 | SPA300-05 | 5 | 300 | 305,5 | 7 | 3535 | 90 | 25 | 80 | 265 | 4,5 | 89 | 4,5 | 175 |
| AT03155 | SPA315-05 | 5 | 315 | 320,5 | 7 | 3535 | 90 | 25 | 80 | 280 | 4,5 | 89 | 4,5 | 175 |
| AT03555 | SPA355-05 | 5 | 355 | 360,5 | 4 | 3535 | 90 | - | 80 | 320 | 4,5 | 89 | 4,5 | 175 |
| AT04005 | SPA400-05 | 5 | 400 | 405,5 | 4 | 3535 | 90 | - | 80 | 365 | 4,5 | 89 | 4,5 | 175 |
| AT04505 | SPA450-05 | 5 | 450 | 455,5 | 4 | 3535 | 90 | - | 80 | 415 | 4,5 | 89 | 4,5 | 175 |
| AT05005 | SPA500-05 | 5 | 500 | 505,5 | 4 | 3535 | 90 | - | 80 | 465 | 4,5 | 89 | 4,5 | 175 |
| AT05605 | SPA560-05 | 5 | 560 | 565,5 | 4 | 3535 | 90 | - | 80 | 525 | 4,5 | 89 | 4,5 | 175 |
| AT06305 | SPA630-05 | 5 | 630 | 635,5 | 4 | 3535 | 90 | - | 80 | 595 | 4,5 | 89 | 4,5 | 175 |
| AT08005 | SPA800-05 | 5 | 800 | 805,5 | 4 | 4040 | 100 | - | 80 | 765 | 11,0 | 102 | 11,0 | 210 |
| AT10005 | SPA1000-05 | 5 | 1000 | 1005,5 | 4 | 4545 | 110 | - | 80 | 965 | 17,0 | 114 | 17,0 | 242 |

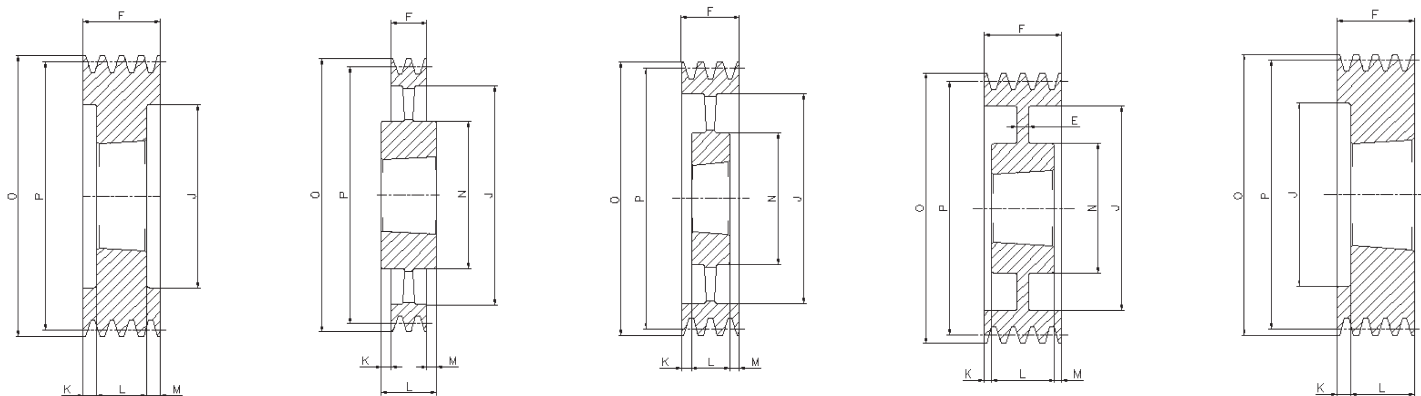

3

4

5

6

8

SPA/6

| Cod. interno Internal code Intern Code Code interne Código interno | Tipo Type Typ Type Tipo | Gole Grooves Rillen Gorges Canales | P | O | Forma Forme Forme Forme Forma | Bussola Bush Buchse Moyeu Casquillo | ∅ MAX | E | F | J | K | L | M | N |
|--|-------------------------------------|--|------|--------|---|---|----------|----|----|-----|------|-----|------|-----|
| AT01006 | SPA100-06 | 6 | 100 | 105,5 | 3 | 1610 | 42 | - | 95 | 66 | 30,0 | 25 | 40,0 | - |
| AT01066 | SPA106-06 | 6 | 106 | 111,5 | 8 | 2012 | 50 | - | 95 | 72 | 63,0 | 32 | - | - |
| AT01126 | SPA112-06 | 6 | 112 | 117,5 | 8 | 2012 | 50 | - | 95 | 78 | 63,0 | 32 | - | - |
| AT01186 | SPA118-06 | 6 | 118 | 123,5 | 8 | 2012 | 50 | - | 95 | 84 | 63,0 | 32 | - | - |
| AT01256 | SPA125-06 | 6 | 125 | 130,5 | 3 | 2012 | 50 | - | 95 | 91 | 31,5 | 32 | 31,5 | - |
| AT01326 | SPA132-06 | 6 | 132 | 137,5 | 3 | 2517 | 60 | - | 95 | 98 | 25,0 | 45 | 25,0 | - |
| AT01406 | SPA140-06 | 6 | 140 | 145,5 | 3 | 2517 | 60 | - | 95 | 106 | 25,0 | 45 | 25,0 | - |
| AT01506 | SPA150-06 | 6 | 150 | 155,5 | 3 | 2517 | 60 | - | 95 | 116 | 25,0 | 45 | 25,0 | - |
| AT01606 | SPA160-06 | 6 | 160 | 165,5 | 3 | 2517 | 60 | - | 95 | 125 | 25,0 | 45 | 25,0 | - |
| AT01806 | SPA180-06 | 6 | 180 | 185,5 | 3 | 3020 | 75 | - | 95 | 146 | 22,0 | 51 | 22,0 | - |
| AT02006 | SPA200-06 | 6 | 200 | 205,5 | 3 | 3020 | 75 | - | 95 | 165 | 22,0 | 51 | 22,0 | - |
| AT02126 | SPA212-06 | 6 | 212 | 217,5 | 3 | 3020 | 75 | - | 95 | 176 | 22,0 | 51 | 22,0 | - |
| AT02246 | SPA224-06 | 6 | 224 | 229,5 | 3 | 3020 | 75 | - | 95 | 189 | 22,0 | 51 | 22,0 | - |
| AT02366 | SPA236-06 | 6 | 236 | 241,5 | 3 | 3020 | 75 | - | 95 | 202 | 22,0 | 51 | 22,0 | - |
| AT02506 | SPA250-06 | 6 | 250 | 255,5 | 6 | 3020 | 75 | 20 | 95 | 215 | 22,0 | 51 | 22,0 | 155 |
| AT02806 | SPA280-06 | 6 | 280 | 285,5 | 6 | 3535 | 90 | 25 | 95 | 245 | 3,0 | 89 | 3,0 | 175 |
| AT03006 | SPA300-06 | 6 | 300 | 305,5 | 6 | 3535 | 90 | 25 | 95 | 265 | 3,0 | 89 | 3,0 | 175 |
| AT03156 | SPA315-06 | 6 | 315 | 320,5 | 6 | 3535 | 90 | 25 | 95 | 280 | 3,0 | 89 | 3,0 | 175 |
| AT03556 | SPA355-06 | 6 | 355 | 360,5 | 5 | 3535 | 90 | - | 95 | 320 | 3,0 | 89 | 3,0 | 175 |
| AT04006 | SPA400-06 | 6 | 400 | 405,5 | 5 | 3535 | 90 | - | 95 | 365 | 3,0 | 89 | 3,0 | 175 |
| AT04506 | SPA450-06 | 6 | 450 | 455,5 | 5 | 3535 | 90 | - | 95 | 415 | 3,0 | 89 | 3,0 | 175 |
| AT05006 | SPA500-06 | 6 | 500 | 505,5 | 5 | 3535 | 90 | - | 95 | 465 | 3,0 | 89 | 3,0 | 175 |
| AT05606 | SPA560-06 | 6 | 560 | 565,5 | 5 | 3535 | 90 | - | 95 | 525 | 3,0 | 89 | 3,0 | 175 |
| AT06306 | SPA630-06 | 6 | 630 | 635,5 | 4 | 4040 | 100 | - | 95 | 595 | 3,5 | 102 | 3,5 | 210 |
| AT08006 | SPA800-06 | 6 | 800 | 805,5 | 4 | 4040 | 100 | - | 95 | 765 | 3,5 | 102 | 3,5 | 210 |
| AT10006 | SPA1000-06 | 6 | 1000 | 1005,5 | 4 | 4545 | 110 | - | 95 | 965 | 9,5 | 114 | 9,5 | 242 |

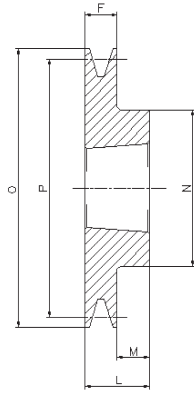

1

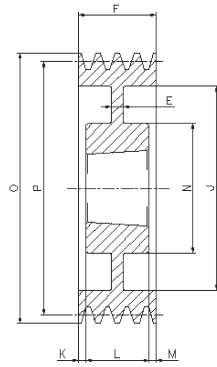

6

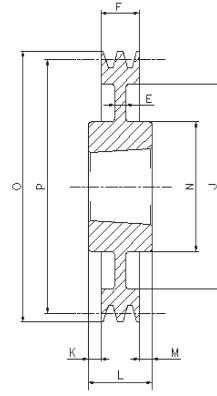

7

SPB/1

| Cod. interno Internal code Intern Code Code interne Código interno | Tipo Type Typ Type Tipo | Gole Grooves Rillen Gorges Canales | P | O | Forma Form Forme Forme Forma | Bussola Bush Buchse Moyeu Casquillo | Ø MAX | E | F | J | K | L | M | N |
|--|-------------------------------------|--|-----|-----|--|---|----------|----|----|-----|-----|----|-----|-----|
| BT01001 | SPB100-01 | 1 | 100 | 107 | 1 | 1610 | 42 | - | 25 | - | - | 25 | - | - |
| BT01061 | SPB106-1 | 1 | 106 | 113 | 1 | 1610 | 42 | - | 25 | - | - | 25 | - | - |
| BT01121 | SPB112-01 | 1 | 112 | 119 | 1 | 1610 | 42 | - | 25 | - | - | 25 | - | - |
| BT01181 | SPB118-01 | 1 | 118 | 125 | 1 | 1610 | 42 | - | 25 | - | - | 25 | - | - |
| BT01251 | SPB125-01 | 1 | 125 | 132 | 1 | 1610 | 42 | - | 25 | - | - | 25 | - | - |
| BT01321 | SPB132-01 | 1 | 132 | 139 | 1 | 1610 | 42 | - | 25 | - | - | 25 | - | - |
| BT01401 | SPB140-01 | 1 | 140 | 147 | 1 | 1610 | 42 | - | 25 | - | - | 25 | - | - |
| BT01501 | SPB150-01 | 1 | 150 | 157 | 1 | 1610 | 42 | - | 25 | - | - | 25 | - | - |
| BT01601 | SPB160-01 | 1 | 160 | 167 | 1 | 1610 | 42 | - | 25 | - | - | 25 | - | - |
| BT01701 | SPB170-01 | 1 | 170 | 177 | 1 | 1610 | 42 | - | 25 | - | - | 25 | - | - |
| BT01801 | SPB180-01 | 1 | 180 | 187 | 6 | 1610 | 42 | 15 | 25 | 132 | - | 25 | - | 90 |
| BT01901 | SPB190-01 | 1 | 190 | 197 | 7 | 2012 | 50 | 15 | 25 | 147 | 3,5 | 32 | 3,5 | 104 |
| BT02001 | SPB200-01 | 1 | 200 | 207 | 7 | 2012 | 50 | 15 | 25 | 157 | 3,5 | 32 | 3,5 | 104 |
| BT02121 | SPB212-01 | 1 | 212 | 219 | 7 | 2012 | 50 | 15 | 25 | 169 | 3,5 | 32 | 3,5 | 104 |
| BT02241 | SPB224-01 | 1 | 224 | 231 | 7 | 2012 | 50 | 15 | 25 | 181 | 3,5 | 32 | 3,5 | 104 |
| BT02361 | SPB236-01 | 1 | 236 | 243 | 7 | 2012 | 50 | 15 | 25 | 193 | 3,5 | 32 | 3,5 | 104 |
| BT02501 | SPB250-01 | 1 | 250 | 257 | 7 | 2012 | 50 | 20 | 25 | 207 | 3,5 | 32 | 3,5 | 104 |
| BT02801 | SPB280-01 | 1 | 280 | 287 | 7 | 2012 | 50 | 20 | 25 | 237 | 3,5 | 32 | 3,5 | 104 |
| BT03001 | SPB300-01 | 1 | 300 | 307 | 7 | 2012 | 50 | 20 | 25 | 258 | 3,5 | 32 | 3,5 | 104 |
| BT03151 | SPB315-01 | 1 | 315 | 322 | 7 | 2012 | 50 | 20 | 25 | 272 | 3,5 | 32 | 3,5 | 104 |

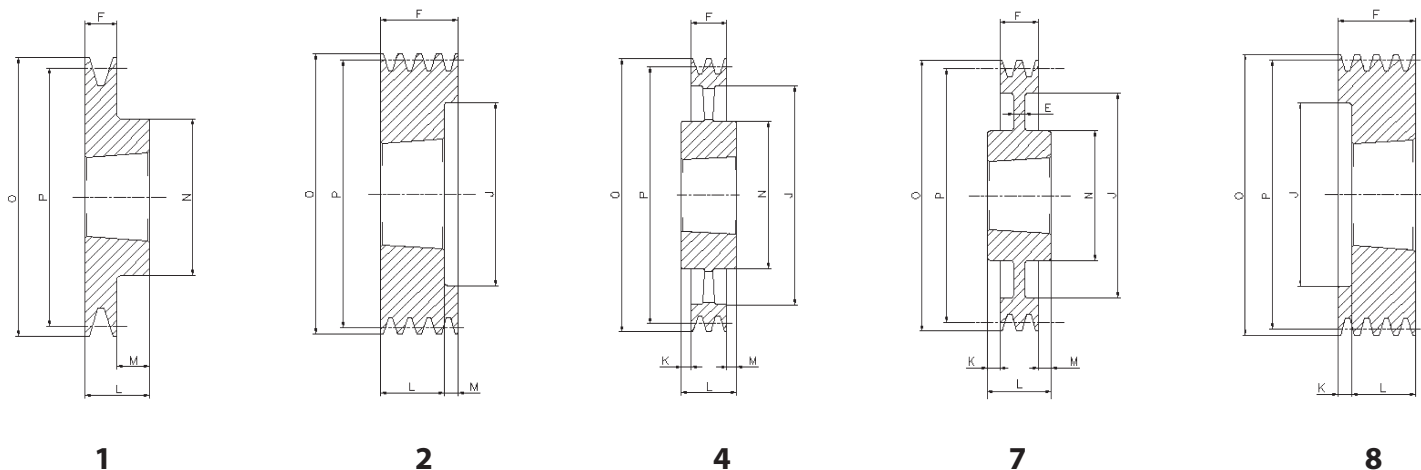

SPB/2

| Cod. interno Internal code Intern Code Code interne Código interno | Tipo Type Typ Type Tipo | Gole Grooves Rillen Gorges Canales | P | O | Forma Form Forme Forme Forma | Bussola Bush Buchse Moyeu Casquillo | ∅ MAX | E | F | J | K | L | M | N |
|--|-------------------------------------|--|------------|-----|--|---|----------|----|----|-----|------|----|------|-----|
| BT01002 | SPB100-02 | 2 | 100 | 107 | 8 | 1610 | 42 | - | 44 | 62 | 19,0 | 25 | - | - |
| BT01062 | SPB106-02 | 2 | 106 | 113 | 8 | 1610 | 42 | - | 44 | 67 | 19,0 | 25 | - | - |
| BT01122 | SPB112-02 | 2 | 112 | 119 | 8 | 1610 | 42 | - | 44 | 72 | 19,0 | 25 | - | - |
| BT01182 | SPB118-02 | 2 | 118 | 125 | 2 | 1610 | 42 | - | 44 | 78 | - | 25 | 19,0 | - |
| BT01252 | SPB125-02 | 2 | 125 | 132 | 2 | 2012 | 50 | - | 44 | 82 | - | 32 | 12,0 | - |
| BT01322 | SPB132-02 | 2 | 132 | 139 | 2 | 2012 | 50 | - | 44 | 89 | - | 32 | 12,0 | - |
| BT01402 | SPB140-02 | 2 | 140 | 147 | 2 | 2012 | 50 | - | 44 | 97 | - | 32 | 12,0 | - |
| BT01502 | SPB150-02 | 2 | 150 | 157 | 2 | 2012 | 50 | - | 44 | 107 | - | 32 | 12,0 | - |
| BT01602 | SPB160-02 | 2 | 160 | 167 | 2 | 2012 | 50 | - | 44 | 117 | - | 32 | 12,0 | - |
| BT01702 | SPB170-02 | 2 | 170 | 177 | 2 | 2012 | 50 | - | 44 | 127 | - | 32 | 12,0 | - |
| BT01802 | SPB180-02 | 2 | 180 | 187 | 1 | 2517 | 60 | - | 44 | - | - | 45 | 1,0 | 120 |
| BT01902 | SPB190-02 | 2 | 190 | 197 | 1 | 2517 | 60 | - | 44 | - | - | 45 | 1,0 | 120 |
| BT02002 | SPB200-02 | 2 | 200 | 207 | 1 | 2517 | 60 | - | 44 | - | - | 45 | 1,0 | 117 |
| BT02122 | SPB212-02 | 2 | 212 | 219 | 7 | 2517 | 60 | 20 | 44 | 169 | - | 45 | 1,0 | 117 |
| BT02242 | SPB224-02 | 2 | 224 | 231 | 7 | 2517 | 60 | 15 | 44 | 181 | - | 45 | 1,0 | 117 |
| BT02362 | SPB236-02 | 2 | 236 | 243 | 7 | 2517 | 60 | 15 | 44 | 193 | - | 45 | 1,0 | 117 |
| BT02502 | SPB250-02 | 2 | 250 | 257 | 7 | 2517 | 60 | 20 | 44 | 207 | - | 45 | 1,0 | 125 |
| BT02802 | SPB280-02 | 2 | 280 | 287 | 7 | 2517 | 60 | 20 | 44 | 237 | - | 45 | 1,0 | 125 |
| BT03002 | SPB300-02 | 2 | 300 | 307 | 7 | 2517 | 60 | 20 | 44 | 257 | - | 45 | 1,0 | 125 |
| BT03152 | SPB315-02 | 2 | 315 | 322 | 7 | 2517 | 60 | 20 | 44 | 272 | - | 45 | 1,0 | 125 |
| BT03352 | SPB335-02 | 2 | 335 | 342 | 7 | 2517 | 60 | 20 | 44 | 292 | - | 45 | 1,0 | 125 |
| BT03552 | SPB355-02 | 2 | 355 | 362 | 7 | 3020 | 75 | 15 | 44 | 312 | 3,5 | 51 | 3,5 | 144 |
| BT04002 | SPB400-02 | 2 | 400 | 407 | 4 | 3020 | 75 | - | 44 | 357 | 3,5 | 51 | 3,5 | 150 |
| BT04502 | SPB450-02 | 2 | 450 | 457 | 4 | 3020 | 75 | - | 44 | 407 | 3,5 | 51 | 3,5 | 150 |
| BT05002 | SPB500-02 | 2 | 500 | 507 | 4 | 3020 | 75 | - | 44 | 457 | 3,5 | 51 | 3,5 | 150 |
| BT05602 | SPB560-02 | 2 | 560 | 567 | 4 | 3030 | 75 | - | 44 | 517 | 4,0 | 76 | 28,0 | 150 |
| BT06302 | SPB630-02 | 2 | 630 | 637 | 4 | 3030 | 75 | - | 44 | 587 | 16,0 | 76 | 16,0 | 150 |

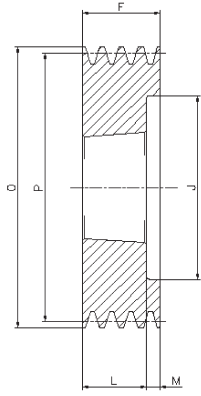

2

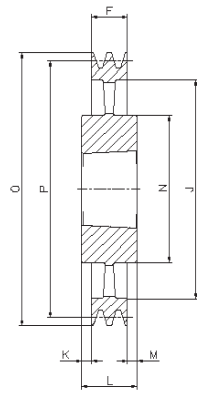

4

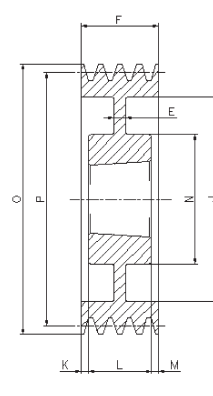

6

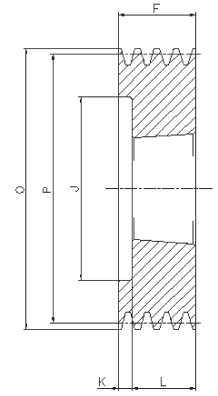

8

SPB/3

| Cod. interno Internal code Intern Code Code interne Código interno | Tipo Type Typ Type Tipo | Gole Grooves Rillen Gorges Canales | P | O | Forma Form Forme Forme Forma | Bussola Bush Buchse Moyeu Casquillo | Ø MAX | E | F | J | K | L | M | N |
|--|-------------------------------------|--|------|------|--|---|----------|----|----|------|------|-----|------|-----|
| BT01003 | SPB100-03 | 3 | 100 | 107 | 8 | 1610 | 42 | - | 63 | 62 | 38,0 | 25 | - | - |
| BT01063 | SPB106-03 | 3 | 106 | 113 | 8 | 1610 | 42 | - | 63 | 67 | 38,0 | 25 | - | - |
| BT01123 | SPB112-03 | 3 | 112 | 119 | 8 | 1610 | 42 | - | 63 | 72 | 38,0 | 25 | - | - |
| BT01183 | SPB118-03 | 3 | 118 | 125 | 2 | 1610 | 42 | - | 63 | 78 | - | 25 | 38,0 | - |
| BT01253 | SPB125-03 | 3 | 125 | 132 | 2 | 2012 | 50 | - | 63 | 82 | - | 32 | 31,0 | - |
| BT01323 | SPB132-03 | 3 | 132 | 139 | 2 | 2012 | 50 | - | 63 | 89 | - | 32 | 31,0 | - |
| BT01403 | SPB140-03 | 3 | 140 | 147 | 2 | 2012 | 50 | - | 63 | 97 | - | 32 | 31,0 | - |
| BT01503 | SPB150-03 | 3 | 150 | 157 | 2 | 2517 | 60 | - | 63 | 107 | - | 45 | 18,0 | - |
| BT01603 | SPB160-03 | 3 | 160 | 167 | 2 | 2517 | 60 | - | 63 | 117 | - | 45 | 18,0 | - |
| BT01703 | SPB170-03 | 3 | 170 | 177 | 2 | 2517 | 60 | - | 63 | 127 | - | 45 | 18,0 | - |
| BT01803 | SPB180-03 | 3 | 180 | 187 | 2 | 2517 | 60 | - | 63 | 137 | - | 45 | 18,0 | - |
| BT01903 | SPB190-03 | 3 | 190 | 197 | 2 | 2517 | 60 | - | 63 | 147 | - | 45 | 18,0 | - |
| BT02003 | SPB200-03 | 3 | 200 | 207 | 2 | 2517 | 60 | - | 63 | 157 | - | 45 | 18,0 | - |
| BT02123 | SPB212-03 | 3 | 212 | 219 | 6 | 2517 | 60 | 15 | 63 | 169 | - | 45 | 18,0 | 117 |
| BT02243 | SPB224-03 | 3 | 224 | 231 | 6 | 2517 | 60 | 15 | 63 | 181 | - | 45 | 18,0 | 117 |
| BT02363 | SPB236-03 | 3 | 236 | 243 | 6 | 2517 | 60 | 15 | 63 | 193 | - | 45 | 18,0 | 117 |
| BT02503 | SPB250-03 | 3 | 250 | 257 | 6 | 3020 | 75 | 20 | 63 | 207 | - | 51 | 12,0 | 144 |
| BT02803 | SPB280-03 | 3 | 280 | 287 | 6 | 3020 | 75 | 20 | 63 | 237 | 6,0 | 51 | 6,0 | 144 |
| BT03003 | SPB300-03 | 3 | 300 | 307 | 6 | 3020 | 75 | 20 | 63 | 257 | 6,0 | 51 | 6,0 | 144 |
| BT03153 | SPB315-03 | 3 | 315 | 322 | 6 | 3020 | 75 | 20 | 63 | 272 | 6,0 | 51 | 6,0 | 144 |
| BT03353 | SPB335-03 | 3 | 335 | 342 | 6 | 3020 | 75 | 20 | 63 | 292 | 6,0 | 51 | 6,0 | 144 |
| BT03553 | SPB355-03 | 3 | 355 | 362 | 6 | 3020 | 75 | 15 | 63 | 312 | 6,0 | 51 | 6,0 | 144 |
| BT04003 | SPB400-03 | 3 | 400 | 407 | 4 | 3535 | 90 | - | 63 | 357 | 13,0 | 89 | 13,0 | 175 |
| BT04503 | SPB450-03 | 3 | 450 | 457 | 4 | 3535 | 90 | - | 63 | 407 | - | 89 | 26,0 | 175 |
| BT05003 | SPB500-03 | 3 | 500 | 507 | 4 | 3535 | 90 | - | 63 | 457 | - | 89 | 26,0 | 175 |
| BT05603 | SPB560-03 | 3 | 560 | 567 | 4 | 3535 | 90 | - | 63 | 517 | - | 89 | 26,0 | 175 |
| BT06303 | SPB630-03 | 3 | 630 | 637 | 4 | 3535 | 90 | - | 63 | 587 | - | 89 | 26,0 | 175 |
| BT07103 | SPB710-03 | 3 | 710 | 717 | 4 | 3535 | 90 | - | 63 | 664 | 13,0 | 89 | 13,0 | 175 |
| BT08003 | SPB800-03 | 3 | 800 | 807 | 4 | 3535 | 90 | - | 63 | 754 | 13,0 | 89 | 13,0 | 175 |
| BT09003 | SPB900-03 | 3 | 900 | 907 | 4 | 3535 | 90 | - | 63 | 854 | 13,0 | 89 | 13,0 | 175 |
| BT10003 | SPB1000-03 | 3 | 1000 | 1007 | 4 | 4040 | 100 | - | 63 | 954 | 19,5 | 102 | 19,5 | 210 |
| BT12503 | SPB1250-03 | 3 | 1250 | 1257 | 4 | 4040 | 100 | - | 63 | 1204 | 19,5 | 102 | 19,5 | 210 |

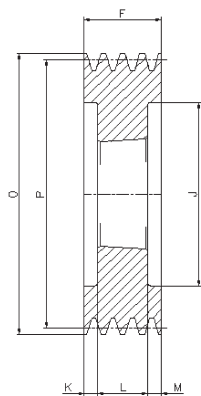

3

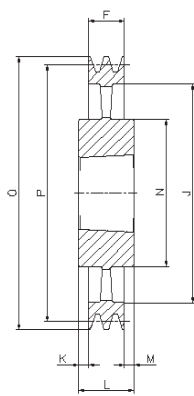

4

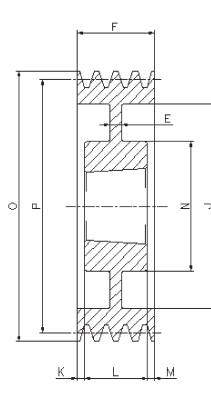

6

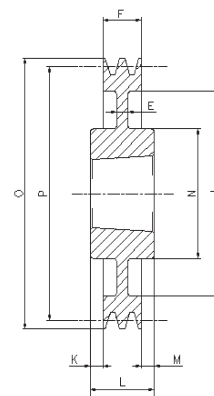

7

SPB/4

| Cod. interno Internal code Interne Code Code interne Código interno | Tipo Type Typ Type Tipo | Gole Grooves Rillen Gorges Canales | P | O | Forma Form Forme Forme Forma | Bussola Bush Buchse Moyeu Casquillo | Ø MAX | E | F | J | K | L | M | N |
|---|-------------------------------------|--|------|------|--|---|----------|----|----|------|------|-----|------|-----|
| BT01004 | SPB100-04 | 4 | 100 | 117 | 8 | 1615 | 42 | - | 82 | 60 | 44,0 | 38 | - | - |
| BT01124 | SPB112-04 | 4 | 112 | 119 | 8 | 2012 | 42 | - | 82 | 72 | 50,0 | 32 | - | - |
| BT01184 | SPB118-04 | 4 | 118 | 125 | 8 | 1610 | 42 | - | 82 | 75 | 57,0 | 25 | - | - |
| BT01254 | SPB125-04 | 4 | 125 | 132 | 3 | 2012 | 50 | - | 82 | 82 | 25,0 | 32 | 25,0 | - |
| BT01324 | SPB132-04 | 4 | 132 | 139 | 3 | 2012 | 50 | - | 82 | 89 | 25,0 | 32 | 25,0 | - |
| BT01404 | SPB140-04 | 4 | 140 | 147 | 3 | 2517 | 60 | - | 82 | 100 | 18,5 | 45 | 18,5 | - |
| BT01504 | SPB150-04 | 4 | 150 | 157 | 3 | 2517 | 60 | - | 82 | 107 | 18,5 | 45 | 18,5 | - |
| BT01604 | SPB160-04 | 4 | 160 | 167 | 3 | 2517 | 60 | - | 82 | 117 | 18,5 | 45 | 18,5 | - |
| BT01704 | SPB170-04 | 4 | 170 | 177 | 3 | 2517 | 60 | - | 82 | 127 | 18,5 | 45 | 18,5 | - |
| BT01804 | SPB180-04 | 4 | 180 | 187 | 3 | 2517 | 60 | - | 82 | 137 | 18,5 | 45 | 18,5 | - |
| BT01904 | SPB190-04 | 4 | 190 | 197 | 3 | 2517 | 60 | - | 82 | 147 | 18,5 | 45 | 18,5 | - |
| BT02004 | SPB200-04 | 4 | 200 | 207 | 3 | 3020 | 75 | - | 82 | 157 | 15,5 | 51 | 15,5 | - |
| BT02124 | SPB212-04 | 4 | 212 | 219 | 3 | 3020 | 75 | - | 82 | 169 | 15,5 | 51 | 15,5 | - |
| BT02244 | SPB224-04 | 4 | 224 | 231 | 3 | 3020 | 75 | - | 82 | 181 | 15,5 | 51 | 15,5 | - |
| BT02364 | SPB236-04 | 4 | 236 | 243 | 3 | 3020 | 75 | - | 82 | 193 | 15,5 | 51 | 15,5 | - |
| BT02504 | SPB250-04 | 4 | 250 | 257 | 6 | 3020 | 75 | 25 | 82 | 207 | 15,5 | 51 | 15,5 | 144 |
| BT02804 | SPB280-04 | 4 | 280 | 287 | 6 | 3020 | 75 | 25 | 82 | 237 | 15,5 | 51 | 15,5 | 144 |
| BT03004 | SPB300-04 | 4 | 300 | 307 | 7 | 3535 | 90 | 25 | 82 | 257 | - | 89 | 7,0 | 175 |
| BT03154 | SPB315-04 | 4 | 315 | 322 | 7 | 3535 | 90 | 25 | 82 | 272 | 3,5 | 89 | 3,5 | 175 |
| BT03354 | SPB335-04 | 4 | 335 | 342 | 7 | 3535 | 90 | 25 | 82 | 292 | 3,5 | 89 | 3,5 | 175 |
| BT03554 | SPB355-04 | 4 | 355 | 362 | 7 | 3535 | 90 | 25 | 82 | 312 | 3,5 | 89 | 3,5 | 175 |
| BT04004 | SPB400-04 | 4 | 400 | 407 | 4 | 3535 | 90 | - | 82 | 357 | 3,5 | 89 | 3,5 | 175 |
| BT04504 | SPB450-04 | 4 | 450 | 457 | 4 | 3535 | 90 | - | 82 | 407 | - | 89 | 7,0 | 175 |
| BT05004 | SPB500-04 | 4 | 500 | 507 | 4 | 3535 | 90 | - | 82 | 457 | - | 89 | 7,0 | 175 |
| BT05604 | SPB560-04 | 4 | 560 | 567 | 4 | 3535 | 90 | - | 82 | 517 | - | 89 | 7,0 | 175 |
| BT06304 | SPB630-04 | 4 | 630 | 637 | 4 | 3535 | 90 | - | 82 | 587 | - | 89 | 7,0 | 175 |
| BT07104 | SPB710-04 | 4 | 710 | 717 | 4 | 3535 | 90 | - | 82 | 664 | 3,5 | 89 | 3,5 | 175 |
| BT08004 | SPB800-04 | 4 | 800 | 807 | 4 | 4040 | 100 | - | 82 | 754 | 10,0 | 102 | 10,0 | 210 |
| BT09004 | SPB900-04 | 4 | 900 | 907 | 4 | 4040 | 100 | - | 82 | 854 | 10,0 | 102 | 10,0 | 210 |
| BT10004 | SPB1000-04 | 4 | 1000 | 1007 | 4 | 4040 | 100 | - | 82 | 954 | 10,0 | 102 | 16,0 | 210 |
| BT12504 | SPB1250-04 | 4 | 1250 | 1257 | 4 | 4545 | 110 | - | 82 | 1204 | 16,0 | 114 | 16,0 | 210 |

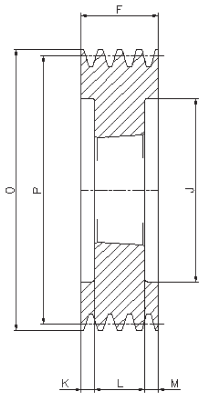

3

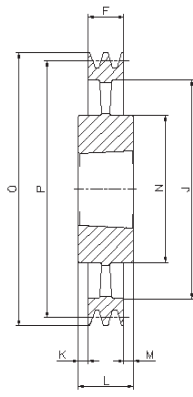

4

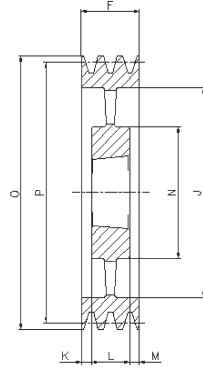

5

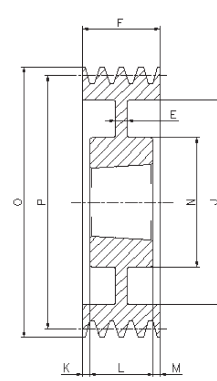

6

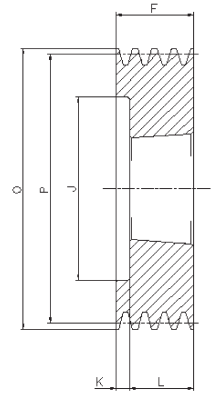

8

SPB/5

| Cod. interno Internal code Internier Code Code interne Código interno | Tipo Type Typ Type Tipo | Gole Grooves Rillen Gorges Canales | P | O | Forma Form Forme Forme Forma | Bussola Bush Buchse Moyeu Casquillo | ∅ MAX | E | F | J | K | L | M | N |
|---|-------------------------------------|--|------|------|--|---|----------|----|-----|------|------|-----|------|-----|
| BT01255 | SPB125-05 | 5 | 125 | 132 | 8 | 2012 | 50 | - | 101 | 87 | 69,0 | 32 | - | - |
| BT01325 | SPB132-05 | 5 | 132 | 139 | 8 | 2517 | 60 | - | 101 | 94 | 56,0 | 45 | - | - |
| BT01405 | SPB140-05 | 5 | 140 | 147 | 3 | 2517 | 60 | - | 101 | 97 | 28,0 | 45 | 28,0 | - |
| BT01505 | SPB150-05 | 5 | 150 | 157 | 3 | 2517 | 60 | - | 101 | 107 | 28,0 | 45 | 28,0 | - |
| BT01605 | SPB160-05 | 5 | 160 | 167 | 3 | 2517 | 60 | - | 101 | 117 | 28,0 | 45 | 28,0 | - |
| BT01705 | SPB170-05 | 5 | 170 | 177 | 3 | 3020 | 75 | - | 101 | 127 | 25,0 | 51 | 25,0 | - |
| BT01805 | SPB180-05 | 5 | 180 | 187 | 3 | 3020 | 75 | - | 101 | 137 | 25,0 | 51 | 25,0 | - |
| BT01905 | SPB190-05 | 5 | 190 | 197 | 3 | 3020 | 75 | - | 101 | 147 | 25,0 | 51 | 25,0 | - |
| BT02005 | SPB200-05 | 5 | 200 | 207 | 3 | 3020 | 75 | - | 101 | 157 | 25,0 | 51 | 25,0 | - |
| BT02125 | SPB212-05 | 5 | 212 | 219 | 3 | 3020 | 75 | - | 101 | 169 | 25,0 | 51 | 25,0 | - |
| BT02245 | SPB224-05 | 5 | 224 | 231 | 3 | 3020 | 75 | - | 101 | 181 | 25,0 | 51 | 25,0 | - |
| BT02365 | SPB236-05 | 5 | 236 | 243 | 3 | 3535 | 90 | - | 101 | 193 | 6,0 | 89 | 6,0 | - |
| BT02505 | SPB250-05 | 5 | 250 | 257 | 3 | 3535 | 90 | - | 101 | 207 | 6,0 | 89 | 6,0 | - |
| BT02805 | SPB280-05 | 5 | 280 | 287 | 6 | 3535 | 90 | 25 | 101 | 237 | 6,0 | 89 | 6,0 | 175 |
| BT03005 | SPB300-05 | 5 | 300 | 307 | 6 | 3535 | 90 | 25 | 101 | 257 | 6,0 | 89 | 6,0 | 175 |
| BT03155 | SPB315-05 | 5 | 315 | 322 | 6 | 3535 | 90 | 25 | 101 | 272 | 6,0 | 89 | 6,0 | 175 |
| BT03355 | SPB335-05 | 5 | 335 | 342 | 6 | 3535 | 90 | 25 | 101 | 292 | 6,0 | 89 | 6,0 | 175 |
| BT03555 | SPB355-05 | 5 | 355 | 362 | 6 | 3535 | 90 | 17 | 101 | 312 | 6,0 | 89 | 6,0 | 175 |
| BT04005 | SPB400-05 | 5 | 400 | 407 | 5 | 3535 | 90 | - | 101 | 357 | 6,0 | 89 | 6,0 | 175 |
| BT04505 | SPB450-05 | 5 | 450 | 457 | 5 | 3535 | 90 | - | 101 | 407 | - | 89 | 12,0 | 175 |
| BT05005 | SPB500-05 | 5 | 500 | 507 | 5 | 3535 | 90 | - | 101 | 457 | - | 89 | 12,0 | 175 |
| BT05605 | SPB560-05 | 5 | 560 | 567 | 4 | 4040 | 100 | - | 101 | 517 | - | 102 | 1,0 | 210 |
| BT06305 | SPB630-05 | 5 | 630 | 637 | 4 | 4040 | 100 | - | 101 | 587 | - | 102 | 1,0 | 210 |
| BT07105 | SPB710-05 | 5 | 710 | 717 | 4 | 4040 | 100 | - | 101 | 664 | - | 102 | 1,0 | 210 |
| BT08005 | SPB800-05 | 5 | 800 | 807 | 4 | 4040 | 100 | - | 101 | 754 | - | 102 | 1,0 | 210 |
| BT09005 | SPB900-05 | 5 | 900 | 907 | 4 | 4040 | 100 | - | 101 | 854 | - | 102 | 1,0 | 210 |
| BT10005 | SPB1000-05 | 5 | 1000 | 1007 | 4 | 4545 | 110 | - | 101 | 954 | 6,5 | 114 | 6,5 | 242 |
| BT12505 | SPB1250-05 | 5 | 1250 | 1257 | 4 | 4545 | 110 | - | 101 | 1204 | 6,5 | 114 | 6,5 | 242 |

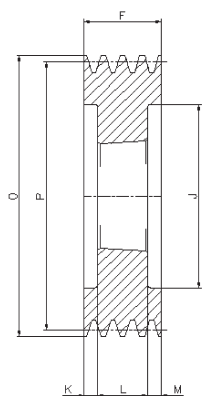

3

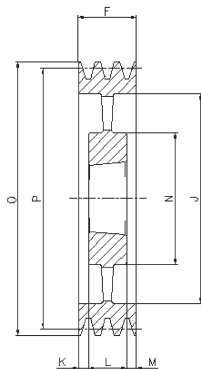

5

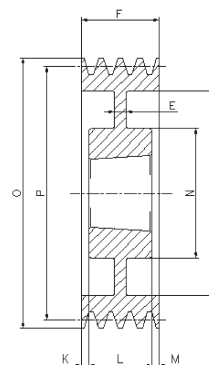

6

SPB/6

| Cod. interno Internal code Intern Code Code interne Código interno | Tipo Type Typ Type Tipo | Gole Grooves Rillen Gorges Canales | P | O | Forma Form Forme Forme Forma | Bussola Buchse Moyeu Casquillo | Ø MAX | E | F | J | K | L | M | N |
|--|-------------------------------------|--|------|------|--|---|----------|----|-----|------|------|-----|------|-----|
| BT01406 | SPB140-06 | 6 | 140 | 147 | 3 | 2517 | 60 | - | 120 | 100 | 37,5 | 45 | 37,5 | - |
| BT01506 | SPB150-06 | 6 | 150 | 157 | 3 | 2517 | 60 | - | 120 | 107 | 37,5 | 45 | 37,5 | - |
| BT01606 | SPB160-06 | 6 | 160 | 167 | 3 | 3020 | 75 | - | 120 | 117 | 34,5 | 51 | 34,5 | - |
| BT01706 | SPB170-06 | 6 | 170 | 177 | 3 | 3020 | 75 | - | 120 | 127 | 34,5 | 51 | 34,5 | - |
| BT01806 | SPB180-06 | 6 | 180 | 187 | 3 | 3020 | 75 | - | 120 | 137 | 34,5 | 51 | 34,5 | - |
| BT01906 | SPB190-06 | 6 | 190 | 197 | 3 | 3020 | 75 | - | 120 | 147 | 34,5 | 51 | 34,5 | - |
| BT02006 | SPB200-06 | 6 | 200 | 207 | 3 | 3020 | 75 | - | 120 | 157 | 34,5 | 51 | 34,5 | - |
| BT02126 | SPB212-06 | 6 | 212 | 219 | 3 | 3535 | 90 | - | 120 | 169 | 15,5 | 89 | 15,5 | - |
| BT02246 | SPB224-06 | 6 | 224 | 231 | 3 | 3535 | 90 | - | 120 | 181 | 15,5 | 89 | 15,5 | - |
| BT02366 | SPB236-06 | 6 | 236 | 243 | 3 | 3535 | 90 | - | 120 | 193 | 15,5 | 89 | 15,5 | - |
| BT02506 | SPB250-06 | 6 | 250 | 257 | 3 | 3535 | 90 | - | 120 | 207 | 15,5 | 89 | 15,5 | - |
| BT02806 | SPB280-06 | 6 | 280 | 287 | 6 | 3535 | 90 | 25 | 120 | 237 | 15,5 | 89 | 15,5 | 175 |
| BT03006 | SPB300-06 | 6 | 300 | 307 | 6 | 3535 | 90 | 25 | 120 | 257 | 15,5 | 89 | 15,5 | 175 |
| BT03156 | SPB315-06 | 6 | 315 | 322 | 6 | 3535 | 90 | 25 | 120 | 272 | 15,5 | 89 | 15,5 | 175 |
| BT03356 | SPB335-06 | 6 | 335 | 342 | 6 | 3535 | 90 | 25 | 120 | 292 | 15,5 | 89 | 15,5 | 175 |
| BT03556 | SPB355-06 | 6 | 355 | 362 | 6 | 3535 | 90 | 25 | 120 | 312 | 15,5 | 89 | 15,5 | 175 |
| BT04006 | SPB400-06 | 6 | 400 | 407 | 5 | 3535 | 90 | - | 120 | 357 | 15,5 | 89 | 15,5 | 175 |
| BT04506 | SPB450-06 | 6 | 450 | 457 | 5 | 4040 | 100 | - | 120 | 407 | - | 102 | 18,0 | 210 |
| BT05006 | SPB500-06 | 6 | 500 | 507 | 5 | 4040 | 100 | - | 120 | 457 | - | 102 | 18,0 | 210 |
| BT05606 | SPB560-06 | 6 | 560 | 567 | 5 | 4040 | 100 | - | 120 | 517 | - | 102 | 18,0 | 210 |
| BT06306 | SPB630-06 | 6 | 630 | 637 | 5 | 4040 | 100 | - | 120 | 587 | - | 102 | 18,0 | 210 |
| BT07106 | SPB710-06 | 6 | 710 | 717 | 5 | 4040 | 100 | - | 120 | 664 | 9,0 | 102 | 9,0 | 210 |
| BT08006 | SPB800-06 | 6 | 800 | 807 | 5 | 4545 | 110 | - | 120 | 754 | 3,0 | 114 | 3,0 | 242 |
| BT09006 | SPB900-06 | 6 | 900 | 907 | 5 | 4545 | 110 | - | 120 | 854 | 3,0 | 114 | 3,0 | 242 |
| BT10006 | SPB1000-06 | 6 | 1000 | 1007 | 5 | 4545 | 110 | - | 120 | 954 | 3,0 | 114 | 3,0 | 242 |
| BT12506 | SPB1250-06 | 6 | 1250 | 1257 | 5 | 4545 | 110 | - | 120 | 1204 | 3,0 | 114 | 3,0 | 242 |

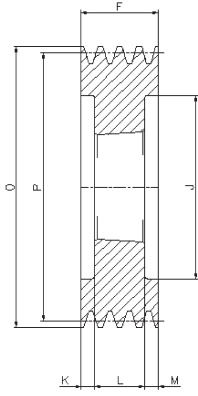

3

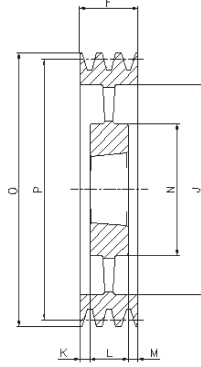

5

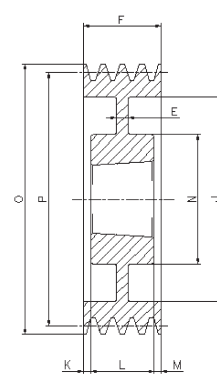

6

SPB/8

| Cod. interno Internal code Internar Code Code interne Código interno | Tipo Type Typ Type Tipo | Gole Grooves Rillen Gorges Canales | P | O | Forma Form Forme Forme Forma | Bussola Bush Buchse Moyeu Casquillo | Ø MAX | E | F | J | K | L | M | N |
|--|-------------------------------------|--|-------------|------|--|---|----------|----|-----|------|------|-----|------|-----|
| BT01408 | SPB140-08 | 8 | 140 | 147 | 3 | 2517 | 60 | - | 158 | 97 | 56,5 | 45 | 56,5 | - |
| BT01608 | SPB160-08 | 8 | 160 | 167 | 3 | 3020 | 75 | - | 158 | 117 | 53,5 | 51 | 53,5 | - |
| BT01708 | SPB170-08 | 8 | 170 | 177 | 3 | 3030 | 75 | - | 158 | 127 | 41,0 | 76 | 41,0 | - |
| BT01808 | SPB180-08 | 8 | 180 | 187 | 3 | 3030 | 75 | - | 158 | 137 | 41,0 | 76 | 41,0 | - |
| BT01908 | SPB190-08 | 8 | 190 | 197 | 3 | 3030 | 75 | - | 158 | 147 | 41,0 | 76 | 41,0 | - |
| BT02008 | SPB200-08 | 8 | 200 | 207 | 3 | 3535 | 90 | - | 158 | 157 | 34,5 | 89 | 34,5 | - |
| BT02128 | SPB212-08 | 8 | 212 | 219 | 3 | 3535 | 90 | - | 158 | 169 | 34,5 | 89 | 34,5 | - |
| BT02248 | SPB224-08 | 8 | 224 | 231 | 3 | 3535 | 90 | - | 158 | 181 | 34,5 | 89 | 34,5 | - |
| BT02368 | SPB236-08 | 8 | 236 | 243 | 3 | 3535 | 90 | - | 158 | 193 | 34,5 | 89 | 34,5 | - |
| BT02508 | SPB250-08 | 8 | 250 | 257 | 3 | 3535 | 90 | - | 158 | 207 | 34,5 | 89 | 34,5 | - |
| BT02808 | SPB280-08 | 8 | 280 | 287 | 6 | 3535 | 90 | 25 | 158 | 237 | 34,5 | 89 | 34,5 | 175 |
| BT03008 | SPB300-08 | 8 | 300 | 307 | 6 | 3535 | 90 | 25 | 158 | 257 | 34,5 | 89 | 34,5 | 175 |
| BT03158 | SPB315-08 | 8 | 315 | 322 | 6 | 3535 | 90 | 25 | 158 | 272 | 34,5 | 89 | 34,5 | 175 |
| BT03358 | SPB335-08 | 8 | 335 | 342 | 6 | 3535 | 90 | 25 | 158 | 292 | 34,5 | 89 | 34,5 | 175 |
| BT03558 | SPB355-08 | 8 | 355 | 362 | 6 | 3535 | 90 | 25 | 158 | 312 | 34,5 | 89 | 34,5 | 175 |
| BT04008 | SPB400-08 | 8 | 400 | 407 | 6 | 4040 | 100 | 30 | 158 | 357 | 28,0 | 102 | 28,0 | 210 |
| BT04508 | SPB450-08 | 8 | 450 | 457 | 5 | 4040 | 100 | - | 158 | 407 | 28,0 | 102 | 28,0 | 210 |
| BT05008 | SPB500-08 | 8 | 500 | 507 | 5 | 4040 | 100 | - | 158 | 457 | 28,0 | 102 | 28,0 | 210 |
| BT05608 | SPB560-08 | 8 | 560 | 567 | 5 | 4545 | 110 | - | 158 | 517 | 22,0 | 114 | 22,0 | 242 |
| BT06308 | SPB630-08 | 8 | 630 | 637 | 5 | 4545 | 110 | - | 158 | 587 | 22,0 | 114 | 22,0 | 242 |
| BT07108 | SPB710-08 | 8 | 710 | 717 | 5 | 4545 | 110 | - | 158 | 664 | 22,0 | 114 | 22,0 | 242 |
| BT08008 | SPB800-08 | 8 | 800 | 807 | 5 | 4545 | 110 | - | 158 | 754 | 22,0 | 114 | 22,0 | 242 |
| BT09008 | SPB900-08 | 8 | 900 | 907 | 5 | 4545 | 110 | - | 158 | 854 | 22,0 | 114 | 22,0 | 242 |
| BT10008 | SPB1000-08 | 8 | 1000 | 1007 | 5 | 5050 | 125 | - | 158 | 954 | 15,5 | 127 | 15,5 | 267 |
| BT12508 | SPB1250-08 | 8 | 1250 | 1257 | 5 | 5050 | 125 | - | 158 | 1204 | 15,5 | 127 | 15,5 | 267 |

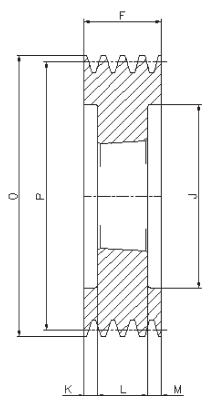

3

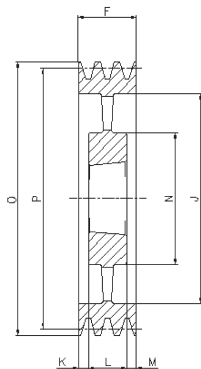

5

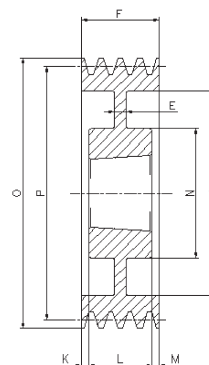

6

SPB/10

| Cod. interno Internal code Intern Code Code interne Código interno | Tipo Type Typ Type Tipo | Gole Grooves Rillen Gorges Canales | P | O | Forma Form Forme Forme Forma | Bussola Bush Buchse Moyeu Casquillo | ∅ MAX | E | F | J | K | L | M | N |
|--|-------------------------------------|--|-------------|------|--|---|----------|----|-----|-----|------|-----|------|-----|
| BT0200X | SPB200-10 | 10 | 200 | 207 | 3 | 3535 | 90 | - | 196 | 157 | 53,5 | 89 | 53,5 | - |
| BT0224X | SPB224-10 | 10 | 224 | 231 | 3 | 3535 | 90 | - | 196 | 181 | 53,5 | 89 | 53,5 | - |
| BT0236X | SPB236-10 | 10 | 236 | 243 | 3 | 3535 | 90 | - | 196 | 193 | 53,5 | 89 | 53,5 | - |
| BT0250X | SPB250-10 | 10 | 250 | 257 | 3 | 3535 | 90 | - | 196 | 207 | 53,5 | 89 | 53,5 | - |
| BT0280X | SPB280-10 | 10 | 280 | 287 | 6 | 3535 | 90 | 30 | 196 | 237 | 53,5 | 89 | 53,5 | 175 |
| BT0315X | SPB315-10 | 10 | 315 | 322 | 6 | 3535 | 90 | 30 | 196 | 272 | 53,5 | 89 | 53,5 | 175 |
| BT0335X | SPB335-10 | 10 | 335 | 342 | 6 | 4040 | 100 | 30 | 196 | 292 | 47,0 | 102 | 47,0 | 210 |
| BT0355X | SPB355-10 | 10 | 355 | 362 | 6 | 4040 | 100 | 30 | 196 | 312 | 47,0 | 102 | 47,0 | 210 |
| BT0400X | SPB400-10 | 10 | 400 | 407 | 6 | 4040 | 100 | 30 | 196 | 357 | 47,0 | 102 | 47,0 | 210 |
| BT0450X | SPB450-10 | 10 | 450 | 457 | 5 | 4545 | 110 | - | 196 | 407 | 41,0 | 114 | 41,0 | 242 |
| BT0500X | SPB500-10 | 10 | 500 | 507 | 5 | 4545 | 110 | - | 196 | 457 | 41,0 | 114 | 41,0 | 242 |
| BT0560X | SPB560-10 | 10 | 560 | 567 | 5 | 4545 | 110 | - | 196 | 517 | 41,0 | 114 | 41,0 | 242 |
| BT0630X | SPB630-10 | 10 | 630 | 637 | 5 | 4545 | 110 | - | 196 | 587 | 41,0 | 114 | 41,0 | 242 |
| BT0710X | SPB710-10 | 10 | 710 | 717 | 5 | 4545 | 110 | - | 196 | 664 | 41,0 | 114 | 41,0 | 242 |
| BT0800X | SPB800-10 | 10 | 800 | 807 | 5 | 4545 | 110 | - | 196 | 754 | 41,0 | 114 | 41,0 | 242 |
| BT0900X | SPB900-10 | 10 | 900 | 907 | 5 | 5050 | 125 | - | 196 | 854 | 34,5 | 127 | 34,5 | 267 |
| BT1000X | SPB1000-10 | 10 | 1000 | 1007 | 5 | 5050 | 125 | - | 196 | 954 | 34,5 | 127 | 34,5 | 267 |

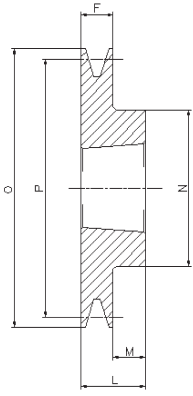

1

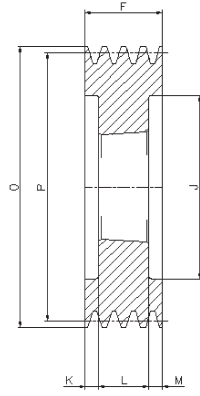

3

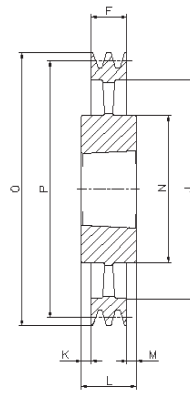

4

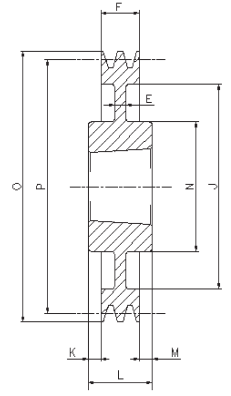

7

SPC/3

| Cod. interno Internal code Intern Code Code interne Código interno | Tipo Type Typ Type Tipo | Gole Grooves Rillen Gorges Canales | P | O | Forma Form Forme Forme Forma | Bussola Bush Buchse Moyeu Casquillo | ∅ MAX | E | F | J | K | L | M | N |
|--|-------------------------------------|--|-------------|--------|--|---|----------|----|----|------|------|-----|------|-----|
| CT02003 | SPC200-03 | 3 | 200 | 209,6 | 3 | 2517 | 60 | - | 85 | 144 | 20,0 | 45 | 20,0 | - |
| CT02123 | SPC212-03 | 3 | 212 | 221,6 | 3 | 3020 | 75 | - | 85 | 156 | 17,0 | 51 | 17,0 | - |
| CT02243 | SPC224-03 | 3 | 224 | 233,6 | 3 | 3020 | 75 | - | 85 | 168 | 17,0 | 51 | 17,0 | - |
| CT02363 | SPC236-03 | 3 | 236 | 245,6 | 3 | 3020 | 75 | - | 85 | 180 | 17,0 | 51 | 17,0 | - |
| CT02503 | SPC250-03 | 3 | 250 | 259,6 | 3 | 3020 | 75 | - | 85 | 194 | 17,0 | 51 | 17,0 | - |
| CT02653 | SPC265-03 | 3 | 265 | 274,6 | 1 | 3535 | 90 | - | 85 | 209 | - | 89 | 4,0 | 175 |
| CT02803 | SPC280-03 | 3 | 280 | 289,6 | 1 | 3535 | 90 | - | 85 | 224 | - | 89 | 4,0 | 175 |
| CT03003 | SPC300-03 | 3 | 300 | 309,6 | 7 | 3535 | 90 | 20 | 85 | 244 | 2,0 | 89 | 2,0 | 175 |
| CT03153 | SPC315-03 | 3 | 315 | 324,6 | 7 | 3535 | 90 | 20 | 85 | 259 | 2,0 | 89 | 2,0 | 175 |
| CT03353 | SPC335-03 | 3 | 335 | 344,6 | 7 | 3535 | 90 | 20 | 85 | 279 | 2,0 | 89 | 2,0 | 175 |
| CT03553 | SPC355-03 | 3 | 355 | 364,6 | 7 | 3535 | 90 | 20 | 85 | 299 | 2,0 | 89 | 2,0 | 175 |
| CT03753 | SPC375-03 | 3 | 375 | 384,6 | 7 | 3535 | 90 | 25 | 85 | 319 | 2,0 | 89 | 2,0 | 175 |
| CT04003 | SPC400-03 | 3 | 400 | 409,6 | 7 | 3535 | 90 | 17 | 85 | 344 | 2,0 | 89 | 2,0 | 175 |
| CT04253 | SPC425-03 | 3 | 425 | 434,6 | 7 | 3535 | 90 | 17 | 85 | 369 | 2,0 | 89 | 2,0 | 175 |
| CT04503 | SPC450-03 | 3 | 450 | 459,6 | 4 | 3535 | 90 | - | 85 | 394 | 2,0 | 89 | 2,0 | 175 |
| CT04753 | SPC475-03 | 3 | 475 | 484,6 | 4 | 3535 | 90 | - | 85 | 419 | 2,0 | 89 | 2,0 | 175 |
| CT05003 | SPC500-03 | 3 | 500 | 509,6 | 4 | 3535 | 90 | - | 85 | 444 | 2,0 | 89 | 2,0 | 175 |
| CT05303 | SPC530-03 | 3 | 530 | 539,6 | 4 | 3535 | 90 | - | 85 | 474 | 2,0 | 89 | 2,0 | 175 |
| CT05603 | SPC560-03 | 3 | 560 | 569,6 | 4 | 3535 | 90 | - | 85 | 504 | 2,0 | 89 | 2,0 | 175 |
| CT06303 | SPC630-03 | 3 | 630 | 639,6 | 4 | 4040 | 100 | - | 85 | 574 | 8,5 | 102 | 8,5 | 210 |
| CT07103 | SPC710-03 | 3 | 710 | 719,6 | 4 | 4545 | 110 | - | 85 | 652 | 14,5 | 114 | 14,5 | 242 |
| CT08003 | SPC800-03 | 3 | 800 | 809,6 | 4 | 4545 | 110 | - | 85 | 737 | 14,5 | 114 | 14,5 | 242 |
| CT10003 | SPC1000-03 | 3 | 1000 | 1009,6 | 4 | 5050 | 125 | - | 85 | 937 | 21,0 | 127 | 21,0 | 267 |
| CT12503 | SPC1250-03 | 3 | 1250 | 1259,6 | 4 | 5050 | 125 | - | 85 | 1187 | 21,0 | 127 | 21,0 | 267 |

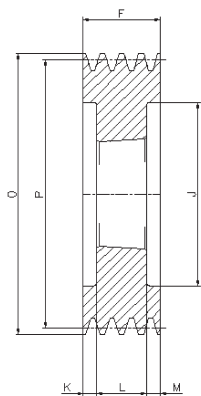

3

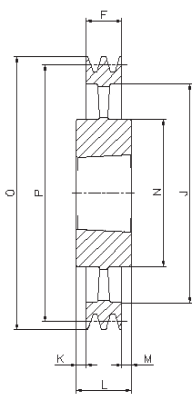

4

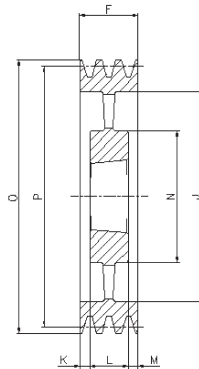

5

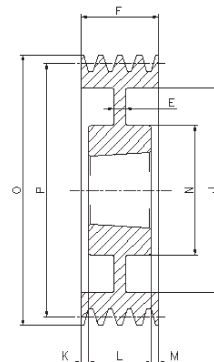

6

SPC/4

| Cod. interno Internal code Intern Code Code interne Código interno | Tipo Type Typ Type Tipo | Gole Grooves Rillen Gorges Canales | P | O | Forma Form Forme Forme Forma | Bussola Bush Buchse Moyeu Casquillo | ∅ MAX | E | F | J | K | L | M | N |
|--|-------------------------------------|--|-------------|--------|--|---|----------|----|-----|------|------|-----|------|-----|
| CT02004 | SPC200-04 | 4 | 200 | 209,6 | 3 | 3020 | 75 | - | 111 | 144 | 30,0 | 51 | 30,0 | - |
| CT02124 | SPC212-04 | 4 | 212 | 221,6 | 3 | 3020 | 75 | - | 111 | 156 | 30,0 | 51 | 30,0 | - |
| CT02244 | SPC224-04 | 4 | 224 | 233,6 | 3 | 3535 | 90 | - | 111 | 168 | 11,0 | 89 | 11,0 | - |
| CT02364 | SPC236-04 | 4 | 236 | 245,6 | 3 | 3535 | 90 | - | 111 | 180 | 11,0 | 89 | 11,0 | - |
| CT02504 | SPC250-04 | 4 | 250 | 259,6 | 3 | 3535 | 90 | - | 111 | 194 | 11,0 | 89 | 11,0 | - |
| CT02654 | SPC265-04 | 4 | 265 | 274,6 | 3 | 3535 | 90 | - | 111 | 209 | 11,0 | 89 | 11,0 | - |
| CT02804 | SPC280-04 | 4 | 280 | 289,6 | 6 | 3535 | 90 | 18 | 111 | 224 | 11,0 | 89 | 11,0 | 175 |
| CT03004 | SPC300-04 | 4 | 300 | 309,6 | 6 | 3535 | 90 | 20 | 111 | 244 | 11,0 | 89 | 11,0 | 175 |
| CT03154 | SPC315-04 | 4 | 315 | 324,6 | 6 | 3535 | 90 | 20 | 111 | 259 | 11,0 | 89 | 11,0 | 175 |
| CT03354 | SPC335-04 | 4 | 335 | 344,6 | 6 | 3535 | 90 | 20 | 111 | 279 | 11,0 | 89 | 11,0 | 175 |
| CT03554 | SPC355-04 | 4 | 355 | 364,6 | 6 | 3535 | 90 | 20 | 111 | 299 | 11,0 | 89 | 11,0 | 175 |
| CT03754 | SPC375-04 | 4 | 375 | 384,6 | 6 | 3535 | 90 | 25 | 111 | 319 | 11,0 | 89 | 11,0 | 175 |
| CT04004 | SPC400-04 | 4 | 400 | 409,6 | 6 | 3535 | 90 | 18 | 111 | 344 | 11,0 | 89 | 11,0 | 175 |
| CT04254 | SPC425-04 | 4 | 425 | 434,6 | 6 | 3535 | 90 | 18 | 111 | 369 | 11,0 | 89 | 11,0 | 175 |
| CT04504 | SPC450-04 | 4 | 450 | 459,6 | 5 | 3535 | 90 | - | 111 | 394 | 11,0 | 89 | 11,0 | 175 |
| CT04754 | SPC475-04 | 4 | 475 | 484,6 | 5 | 3535 | 90 | - | 111 | 419 | 11,0 | 89 | 11,0 | 175 |
| CT05004 | SPC500-04 | 4 | 500 | 509,6 | 5 | 3535 | 90 | - | 111 | 444 | 11,0 | 89 | 11,0 | 175 |
| CT05304 | SPC530-04 | 4 | 530 | 539,6 | 5 | 4040 | 100 | - | 111 | 474 | 4,5 | 102 | 4,5 | 210 |
| CT05604 | SPC560-04 | 4 | 560 | 569,6 | 5 | 4040 | 100 | - | 111 | 504 | 4,5 | 102 | 4,5 | 210 |
| CT06304 | SPC630-04 | 4 | 630 | 639,6 | 4 | 4545 | 110 | - | 111 | 574 | 1,5 | 114 | 1,5 | 242 |
| CT07104 | SPC710-04 | 4 | 710 | 719,6 | 4 | 5050 | 125 | - | 111 | 654 | 8,0 | 127 | 8,0 | 267 |
| CT08004 | SPC800-04 | 4 | 800 | 809,6 | 4 | 5050 | 125 | - | 111 | 737 | 8,0 | 127 | 8,0 | 267 |
| CT10004 | SPC1000-04 | 4 | 1000 | 1009,6 | 4 | 5050 | 125 | - | 111 | 937 | 8,0 | 127 | 8,0 | 267 |
| CT12504 | SPC1250-04 | 4 | 1250 | 1259,6 | 4 | 5050 | 125 | - | 111 | 1187 | 8,0 | 127 | 8,0 | 267 |

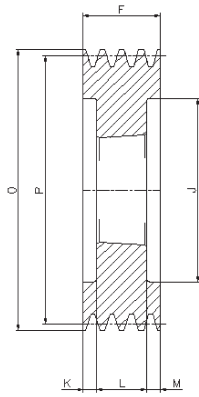

3

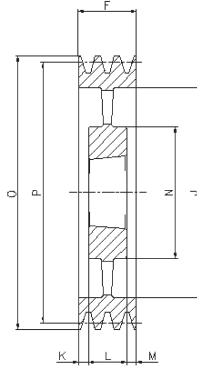

5

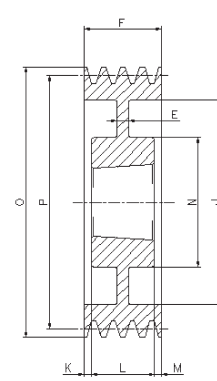

6

SPC/5

| Cod. interno Internal code Intern Code Code interne Código interno | Tipo Type Typ Type Tipo | Gole Grooves Rillen Gorges Canales | P | O | Forma Form Forme Forme Forma | Bussola Bush Buchse Moyeu Casquillo | ∅ MAX | E | F | J | K | L | M | N |
|--|-------------------------------------|--|-------------|--------|--|---|----------|----|-----|------|------|-----|------|-----|
| CT02005 | SPC200-05 | 5 | 200 | 209,6 | 3 | 3535 | 90 | - | 136 | 144 | 23,5 | 89 | 23,5 | - |
| CT02125 | SPC212-05 | 5 | 212 | 221,6 | 3 | 3535 | 90 | - | 136 | 156 | 23,5 | 89 | 23,5 | - |
| CT02245 | SPC224-05 | 5 | 224 | 233,6 | 3 | 3535 | 90 | - | 136 | 168 | 23,5 | 89 | 23,5 | - |
| CT02365 | SPC236-05 | 5 | 236 | 245,6 | 3 | 3535 | 90 | - | 136 | 180 | 23,5 | 89 | 23,5 | - |
| CT02505 | SPC250-05 | 5 | 250 | 259,6 | 3 | 3535 | 90 | - | 136 | 194 | 23,5 | 89 | 23,5 | - |
| CT02655 | SPC265-05 | 5 | 265 | 274,6 | 3 | 3535 | 90 | - | 136 | 209 | 23,5 | 89 | 23,5 | - |
| CT02805 | SPC280-05 | 5 | 280 | 289,6 | 3 | 3535 | 90 | - | 136 | 224 | 23,5 | 89 | 23,5 | - |
| CT03005 | SPC300-05 | 5 | 300 | 309,6 | 6 | 3535 | 90 | 20 | 136 | 244 | 23,5 | 89 | 23,5 | 175 |
| CT03155 | SPC315-05 | 5 | 315 | 324,6 | 6 | 3535 | 90 | 20 | 136 | 259 | 23,5 | 89 | 23,5 | 175 |
| CT03355 | SPC335-05 | 5 | 335 | 344,6 | 6 | 3535 | 90 | 20 | 136 | 279 | 23,5 | 89 | 23,5 | 175 |
| CT03555 | SPC355-05 | 5 | 355 | 364,6 | 6 | 3535 | 90 | 20 | 136 | 299 | 23,5 | 89 | 23,5 | 175 |
| CT03755 | SPC375-05 | 5 | 375 | 384,6 | 6 | 3535 | 90 | 25 | 136 | 319 | 23,5 | 89 | 23,5 | 175 |
| CT04005 | SPC400-05 | 5 | 400 | 409,6 | 6 | 3535 | 90 | 15 | 136 | 344 | 23,5 | 89 | 23,5 | 175 |
| CT04255 | SPC425-05 | 5 | 425 | 434,6 | 6 | 3535 | 90 | 20 | 136 | 369 | 23,5 | 89 | 23,5 | 175 |
| CT04505 | SPC450-05 | 5 | 450 | 459,6 | 5 | 4040 | 100 | - | 136 | 394 | 17,0 | 102 | 17,0 | 210 |
| CT04755 | SPC475-05 | 5 | 475 | 484,6 | 5 | 4040 | 100 | - | 136 | 419 | 17,0 | 102 | 17,0 | 210 |
| CT05005 | SPC500-05 | 5 | 500 | 509,6 | 5 | 4040 | 100 | - | 136 | 444 | 17,0 | 102 | 17,0 | 210 |
| CT05305 | SPC530-05 | 5 | 530 | 539,6 | 5 | 4545 | 110 | - | 136 | 474 | 11,0 | 114 | 11,0 | 240 |
| CT05605 | SPC560-05 | 5 | 560 | 569,6 | 5 | 4545 | 110 | - | 136 | 504 | 11,0 | 114 | 11,0 | 242 |
| CT06305 | SPC630-05 | 5 | 630 | 639,6 | 5 | 5050 | 125 | - | 136 | 574 | 4,5 | 127 | 4,5 | 267 |
| CT07105 | SPC710-05 | 5 | 710 | 719,6 | 5 | 5050 | 125 | - | 136 | 654 | 4,5 | 127 | 4,5 | 267 |
| CT08005 | SPC800-05 | 5 | 800 | 809,6 | 5 | 5050 | 125 | - | 136 | 737 | 4,5 | 127 | 4,5 | 267 |
| CT10005 | SPC1000-05 | 5 | 1000 | 1009,6 | 5 | 5050 | 125 | - | 136 | 937 | 4,5 | 127 | 4,5 | 267 |
| CT12505 | SPC1250-05 | 5 | 1250 | 1259,6 | 5 | 5050 | 125 | - | 136 | 1187 | 4,5 | 127 | 4,5 | 267 |

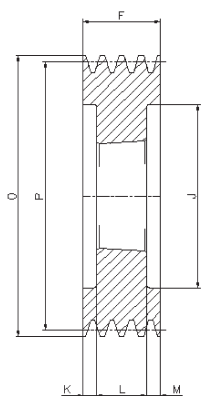

3

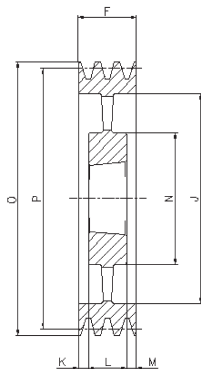

5

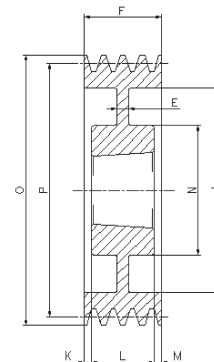

6

SPC/6

| Cod. interno Internal code Intern Code Code interne Código interno | Tipo Type Typ Type Tipo | Gole Grooves Rillen Gorges Canales | P | O | Forma Form Forme Forme Forma | Bussola Bush Buchse Moyeu Casquillo | ∅ MAX | E | F | J | K | L | M | N |
|--|-------------------------------------|--|-------------|--------|--|---|----------|----|-----|------|------|-----|------|-----|
| CT02006 | SPC200-06 | 6 | 200 | 209,6 | 3 | 3535 | 90 | - | 162 | 144 | 36,5 | 89 | 36,5 | - |
| CT02126 | SPC212-06 | 6 | 212 | 221,6 | 3 | 3535 | 90 | - | 162 | 156 | 36,5 | 89 | 36,5 | - |
| CT02246 | SPC224-06 | 6 | 224 | 233,6 | 3 | 3535 | 90 | - | 162 | 168 | 36,5 | 89 | 36,5 | - |
| CT02366 | SPC236-06 | 6 | 236 | 245,6 | 3 | 3535 | 90 | - | 162 | 180 | 36,5 | 89 | 36,5 | - |
| CT02506 | SPC250-06 | 6 | 250 | 259,6 | 3 | 3535 | 90 | - | 162 | 194 | 36,5 | 89 | 36,5 | - |
| CT02656 | SPC265-06 | 6 | 265 | 274,6 | 3 | 3535 | 90 | - | 162 | 209 | 36,5 | 89 | 36,5 | - |
| CT02806 | SPC280-06 | 6 | 280 | 289,6 | 6 | 3535 | 90 | 20 | 162 | 224 | 36,5 | 89 | 36,5 | 175 |
| CT03006 | SPC300-06 | 6 | 300 | 309,6 | 6 | 3535 | 90 | 20 | 162 | 244 | 36,5 | 89 | 36,5 | 175 |
| CT03156 | SPC315-06 | 6 | 315 | 324,6 | 6 | 3535 | 90 | 20 | 162 | 259 | 36,5 | 89 | 36,5 | 175 |
| CT03356 | SPC335-06 | 6 | 335 | 344,6 | 6 | 3535 | 90 | 20 | 162 | 279 | 36,5 | 89 | 36,5 | 175 |
| CT03556 | SPC355-06 | 6 | 355 | 364,6 | 6 | 3535 | 90 | 20 | 162 | 299 | 36,5 | 89 | 36,5 | 175 |
| CT03756 | SPC375-06 | 6 | 375 | 384,6 | 6 | 4040 | 100 | 30 | 162 | 319 | 30,0 | 102 | 30,0 | 210 |
| CT04006 | SPC400-06 | 6 | 400 | 409,6 | 6 | 4040 | 100 | 30 | 162 | 344 | 30,0 | 102 | 30,0 | 210 |
| CT04256 | SPC425-06 | 6 | 425 | 434,6 | 6 | 4040 | 100 | 30 | 162 | 369 | 30,0 | 102 | 24,0 | 210 |
| CT04506 | SPC450-06 | 6 | 450 | 459,6 | 6 | 4545 | 110 | 30 | 162 | 394 | 24,0 | 114 | 24,0 | 242 |
| CT04756 | SPC475-06 | 6 | 475 | 484,6 | 6 | 4545 | 110 | 30 | 162 | 419 | 24,0 | 114 | 24,0 | 242 |
| CT05006 | SPC500-06 | 6 | 500 | 509,6 | 5 | 4545 | 110 | - | 162 | 444 | 24,0 | 114 | 24,0 | 242 |
| CT05306 | SPC530-06 | 6 | 530 | 539,6 | 5 | 5050 | 125 | - | 162 | 474 | 17,5 | 114 | 17,5 | 265 |
| CT05606 | SPC560-06 | 6 | 560 | 569,6 | 5 | 5050 | 125 | - | 162 | 504 | 17,5 | 127 | 17,5 | 267 |
| CT06306 | SPC630-06 | 6 | 630 | 639,6 | 5 | 5050 | 125 | - | 162 | 574 | 17,5 | 127 | 17,5 | 267 |
| CT07106 | SPC710-06 | 6 | 710 | 719,6 | 5 | 5050 | 125 | - | 162 | 654 | 17,5 | 127 | 17,5 | 267 |
| CT08006 | SPC800-06 | 6 | 800 | 809,6 | 5 | 5050 | 125 | - | 162 | 737 | 17,5 | 127 | 17,5 | 267 |
| CT10006 | SPC1000-06 | 6 | 1000 | 1009,6 | 5 | 5050 | 125 | - | 162 | 937 | 17,5 | 127 | 17,5 | 267 |
| CT12506 | SPC1250-06 | 6 | 1250 | 1259,6 | 5 | 5050 | 125 | - | 162 | 1187 | 17,5 | 127 | 17,5 | 267 |

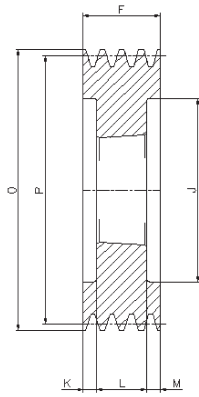

3

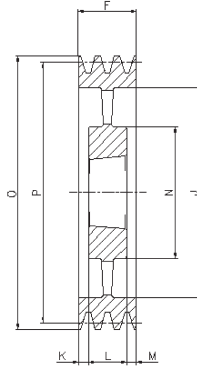

5

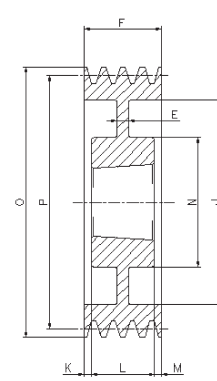

6

SPC/8

| Cod. interno Internal code Intern Code Code interne Código interno | Tipo Type Typ Type Tipo | Gole Grooves Rillen Gorges Canales | P | O | Forma Form Forme Forme Forma | Bussola Bush Buchse Moyeu Casquillo | Ø MAX | E | F | J | K | L | M | N |
|--|-------------------------------------|--|-------------|--------|--|---|----------|----|-----|------|------|-----|------|-----|
| CT02008 | SPC200-08 | 8 | 200 | 209,6 | 3 | 3535 | 90 | - | 213 | 144 | 62,0 | 89 | 62,0 | - |
| CT02128 | SPC212-08 | 8 | 212 | 221,6 | 3 | 3535 | 90 | - | 213 | 156 | 62,0 | 89 | 62,0 | - |
| CT02248 | SPC224-08 | 8 | 224 | 233,6 | 3 | 3535 | 90 | - | 213 | 168 | 62,0 | 89 | 62,0 | - |
| CT02368 | SPC236-08 | 8 | 236 | 245,6 | 3 | 3535 | 90 | - | 213 | 180 | 62,0 | 89 | 62,0 | - |
| CT02508 | SPC250-08 | 8 | 250 | 259,6 | 3 | 3535 | 90 | - | 213 | 194 | 62,0 | 89 | 62,0 | - |
| CT02658 | SPC265-08 | 8 | 265 | 274,6 | 3 | 3535 | 90 | - | 213 | 209 | 62,0 | 89 | 62,0 | - |
| CT02808 | SPC280-08 | 8 | 280 | 289,6 | 3 | 3535 | 90 | - | 213 | 224 | 62,0 | 89 | 62,0 | - |
| CT03008 | SPC300-08 | 8 | 300 | 309,6 | 3 | 4040 | 100 | - | 213 | 244 | 55,5 | 102 | 55,5 | - |
| CT03158 | SPC315-08 | 8 | 315 | 324,6 | 3 | 4040 | 100 | - | 213 | 259 | 55,5 | 102 | 55,5 | - |
| CT03358 | SPC335-08 | 8 | 335 | 344,6 | 6 | 4040 | 100 | 50 | 213 | 279 | 55,5 | 102 | 55,5 | 210 |
| CT03558 | SPC355-08 | 8 | 355 | 364,6 | 6 | 4040 | 100 | 40 | 213 | 299 | 55,5 | 102 | 55,5 | 210 |
| CT03758 | SPC375-08 | 8 | 375 | 384,6 | 6 | 4545 | 110 | 30 | 213 | 319 | 49,5 | 114 | 49,5 | 242 |
| CT04008 | SPC400-08 | 8 | 400 | 409,6 | 6 | 4545 | 110 | 30 | 213 | 344 | 49,5 | 114 | 49,5 | 242 |
| CT04258 | SPC425-08 | 8 | 425 | 434,6 | 6 | 4545 | 110 | 30 | 213 | 369 | 49,5 | 114 | 49,5 | 240 |
| CT04508 | SPC450-08 | 8 | 450 | 459,6 | 6 | 5050 | 125 | 30 | 213 | 394 | 43,0 | 127 | 43,0 | 267 |
| CT04758 | SPC475-08 | 8 | 475 | 484,6 | 6 | 5050 | 125 | 30 | 213 | 419 | 43,0 | 127 | 43,0 | 267 |
| CT04998 | SPC500-08 | 8 | 500 | 509,6 | 6 | 5050 | 125 | 30 | 213 | 444 | 43,0 | 127 | 43,0 | 267 |
| CT05308 | SPC530-08 | 8 | 530 | 539,6 | 6 | 5050 | 125 | 30 | 213 | 474 | 43,0 | 127 | 43,0 | 267 |
| CT05608 | SPC560-08 | 8 | 560 | 569,6 | 5 | 5050 | 125 | - | 213 | 504 | 43,0 | 127 | 43,0 | 267 |
| CT06308 | SPC630-08 | 8 | 630 | 639,6 | 5 | 5050 | 125 | - | 213 | 574 | 43,0 | 127 | 43,0 | 267 |
| CT07108 | SPC710-08 | 8 | 710 | 719,6 | 5 | 5050 | 125 | - | 213 | 654 | 43,0 | 127 | 43,0 | 267 |
| CT08008 | SPC800-08 | 8 | 800 | 809,6 | 5 | 5050 | 125 | - | 213 | 737 | 43,0 | 127 | 43,0 | 267 |
| CT09998 | SPC1000-08 | 8 | 1000 | 1009,6 | 5 | 5050 | 125 | - | 213 | 937 | 43,0 | 127 | 43,0 | 267 |
| CT12508 | SPC1250-08 | 8 | 1250 | 1259,6 | 5 | 5050 | 125 | - | 213 | 1187 | 43,0 | 127 | 43,0 | 267 |

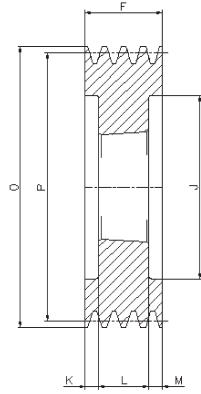

3

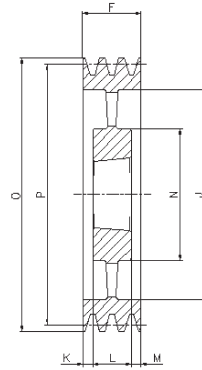

5

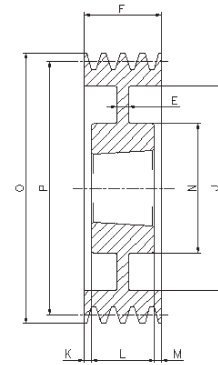

6

SPC/10

| Cod. interno Internal code Intern Code Code interne Código interno | Tipo Type Typ Type Tipo | Gole Grooves Rillen Gorges Canales | P | O | Forma Form Forme Forme Forma | Bussola Bush Buchse Moyeu Casquillo | ∅ MAX | E | F | J | K | L | M | N |
|--|-------------------------------------|--|-------------|--------|--|---|----------|----|-----|------|------|-----|------|-----|
| CT0224X | SPC224-10 | 10 | 224 | 233,6 | 3 | 4040 | 100 | - | 264 | 170 | 81,0 | 102 | 81,0 | - |
| CT0250X | SPC250-10 | 10 | 250 | 259,6 | 3 | 4040 | 100 | - | 264 | 194 | 81,0 | 102 | 81,0 | - |
| CT0280X | SPC280-10 | 10 | 280 | 289,6 | 3 | 4040 | 100 | - | 264 | 224 | 81,0 | 102 | 81,0 | - |
| CT0300X | SPC300-10 | 10 | 300 | 309,6 | 3 | 4545 | 110 | - | 264 | 244 | 75,0 | 114 | 75,0 | - |
| CT0315X | SPC315-10 | 10 | 315 | 324,6 | 3 | 4545 | 110 | - | 264 | 259 | 75,0 | 114 | 75,0 | - |
| CT0355X | SPC355-10 | 10 | 355 | 364,6 | 3 | 4545 | 110 | - | 264 | 299 | 75,0 | 114 | 75,0 | - |
| CT0375X | SPC375-10 | 10 | 375 | 384,6 | 3 | 4545 | 110 | - | 264 | 316 | 75,0 | 114 | 75,0 | - |
| CT0400X | SPC400-10 | 10 | 400 | 409,6 | 6 | 5050 | 125 | 70 | 264 | 344 | 68,5 | 127 | 68,5 | 267 |
| CT0450X | SPC450-10 | 10 | 450 | 459,6 | 6 | 5050 | 125 | 40 | 264 | 394 | 68,5 | 127 | 68,5 | 267 |
| CT0500X | SPC500-10 | 10 | 500 | 509,6 | 6 | 5050 | 125 | 40 | 264 | 444 | 68,5 | 127 | 68,5 | 267 |
| CT0560X | SPC560-10 | 10 | 560 | 569,6 | 5 | 5050 | 125 | - | 264 | 504 | 68,5 | 127 | 68,5 | 267 |
| CT0630X | SPC630-10 | 10 | 630 | 639,6 | 5 | 5050 | 125 | - | 264 | 574 | 68,5 | 127 | 68,5 | 267 |
| CT0710X | SPC710-10 | 10 | 710 | 719,6 | 5 | 5050 | 125 | - | 264 | 654 | 68,5 | 127 | 68,5 | 267 |
| CT0800X | SPC800-10 | 10 | 800 | 809,6 | 5 | 5050 | 125 | - | 264 | 737 | 68,5 | 127 | 68,5 | 267 |
| CT1000X | SPC1000-10 | 10 | 1000 | 1009,6 | 5 | 5050 | 125 | - | 264 | 937 | 68,5 | 127 | 68,5 | 267 |
| CT1250X | SPC1250-10 | 10 | 1250 | 1259,6 | 5 | 5050 | 125 | - | 264 | 1187 | 68,5 | 127 | 68,5 | 267 |